

# BPK-S INTEGRATION

BREHM PRECISION KNEE SYSTEM



SURGICAL TECHNIQUE



**PETER BREHM**  
Die Präzision in Titan  
für den Menschen

## BPK-S INTEGRATION

A single system for every indication

### Preface

In 1999 an interdisciplinary research group of orthopaedists, trauma surgeons, and material scientists set itself the goal of developing an implant system for total knee arthroplasty characterized by minimized particulate wear, sensible soft-tissue management, and optimized patella tracking. The years that followed saw the development of a modern, comprehensive total system that provides a solution for nearly every initial situation in total knee arthroplasty. Moreover, it addresses the challenges posed today by demographic developments and changes in patient behavior. The BPK-S Integration knee system offers new and unique solutions for enhanced protection against instability, aseptic loosening, and material-related complications.

The last decade has witnessed a significant reduction in postoperative instability and aseptic loosening following total arthroplasty. Yet this has been accompanied by increasing numbers of infections and allergic reactions.<sup>1</sup>

BPK-S Integration is the first knee system in the world to offer a completely metal-free treatment option.



**BPK-S Integration UC Ceramic**



**BPK-S Integration UC**

<sup>1</sup> Lombardi AV, Berend KR, Adams JB: Why knee replacements fail in 2013: Patient, Surgeon, or Implant. CCJR Supplement to the Bone Joint J, 96-B (11 Suppl A) 101-4, 2014

## Indications

### Indications

- | Congenital or acquired knee joint defects/deformation which necessitate the implantation of a knee joint replacement
- | Defects or malfunctions of the knee joint
- | Degenerative, rheumatic, post-traumatic arthritis/arthrosis
- | Symptomatic knee instability
- | Reconstruction of flexibility

### Additional indication for components of this system made of ceramic

- | Patients with material hypersensitivity

## 1 Preoperative Planning

The most important goals in total knee arthroplasty are restoration of the desired alignment with the components in correct rotation, functional stability of the knee, preservation of the function of the knee extensors, permanent stable fixation of the implant components, and restoration of the joint line.

As in all arthroplasties, preoperative planning is essential. This is done using A/P and M/L radiographs and, if applicable, supplemented by a full-length view of the lower limb obtained with the patient standing.

Considering correct leg position, one can use the lateral radiographs to estimate the femoral size for the reconstruction of the posterior femoral offset and determine the component size.

Correct reconstruction of the joint line is usually achieved by performing the resections at levels corresponding to the thickness of the implants.

### ! NOTE

With the tibial component, considering the thickness of the plateau (3 mm) and the minimum height of the insert (7 mm). The distal resection level for the BPK-S Integration UC femoral component is 9 mm.

# Table of Contents

<b>1</b>	<b>Preoperative Planning</b>	<b>3</b>
<b>2</b>	<b>Extramedullary Alignment and Tibial Resection</b>	
	Extramedullary Alignment Guide.....	6
	Varus/Valgus and Tibial Slope Adjustments.....	7
	Assembling the Tibial Resection Depth Guide .....	8
	Setting the Tibial Resection Depth .....	9
	Securing the Tibia Extramedullary Alignment Guide .....	9
	Checking Resection Depth .....	9
	Securing the Tibial Resection or Cutting Block.....	10
	Removing the Tibial Alignment Guide .....	11
	Checking Alignment .....	11
	Correcting Tibial Alignment .....	12
	Performing the Resection.....	14
<b>3</b>	<b>Preparing the Femur</b>	
	Preparing the Intramedullary Guide.....	15
	Assembling and Inserting the Intramedullary Guide.....	15
	Determining the Approximate Size of the Femoral Component .....	16
	Placing the Valgus Plate .....	17
	Adjusting Rotation.....	17
	Determining the Size of the Femoral Component .....	21
<b>4</b>	<b>Checking Flexion and Extension Space</b>	
	Checking Flexion Space.....	22
	Checking Extension Space.....	22
<b>5</b>	<b>Femoral Resection</b>	
	Assembling, Attaching, and Aligning the Femoral A/P Resection Guide.....	24
	Performing the Anterior and Posterior Osteotomies .....	26
	Placing the Pins and Disassembling the Device .....	26
	Distal Resection .....	28
	Rechecking Flexion and Extension Space.....	30
	Oblique Osteotomies .....	31
<b>6</b>	<b>Tibial Component</b>	
	Determining the Size of the Tibial Component .....	32
	Resecting Cancellous Bone from the Tibial Head .....	33
	Placing the TRIAL TIBIAL Component UC/SC .....	35
<b>7</b>	<b>Femoral Component</b>	
	Sealing the Femoral Canal.....	36
	Implanting the Femoral Trial.....	36
<b>8</b>	<b>Checking and Correcting Rotation of Fixed UC Polyethylene Inserts</b>	
	Placing the Trial Insert.....	37
	Checking Rotation of the Tibial Component.....	37
	Correcting Rotation of the Tibial Component.....	38
	Drilling the Fixation Holes .....	38
	Impacting the Cancellous Pusher.....	39
<b>9</b>	<b>Placing the Definitive Components</b>	
	Placing the Definitive Tibial Component .....	40
	Placing the Definitive Femoral Component.....	41
	Placing the Definitive PE-Insert UC or DD .....	41

<b>10</b>	<b>Patella Preparation</b>	
	Preparation and Osteotomy of the Patella .....	42
	Determining the Size of the TRIAL Patella .....	44
	Aligning the TRIAL Patella and Drilling the Fixation Holes .....	46
	Implanting the Patella Component .....	47
<b>11</b>	<b>BPK-S Integration Appendix A – BPK-S Integration Ceramic</b>	
	Notes on BPK-S Integration Ceramic.....	49
	Special Femoral Seating Instruments (Ceramic).....	50
	Special Tibial Seating Instruments (Ceramic).....	51
<b>12</b>	<b>BPK-S Integration Appendix B – Size Combinations</b>	
	Size Combinations for Femoral and Tibial Components (Primary).....	52
	Size Combinations for Femoral and Patellar Components (Primary).....	52
<b>13</b>	<b>BPK-S Integration Appendix C – UC and UC/SC Components</b>	<b>53</b>
<b>14</b>	<b>BPK-S Integration Appendix D – System Overview</b>	<b>54</b>
<b>15</b>	<b>BPK-S Integration Appendix E – Dimensions – Femoral and Tibial Components</b>	<b>56</b>

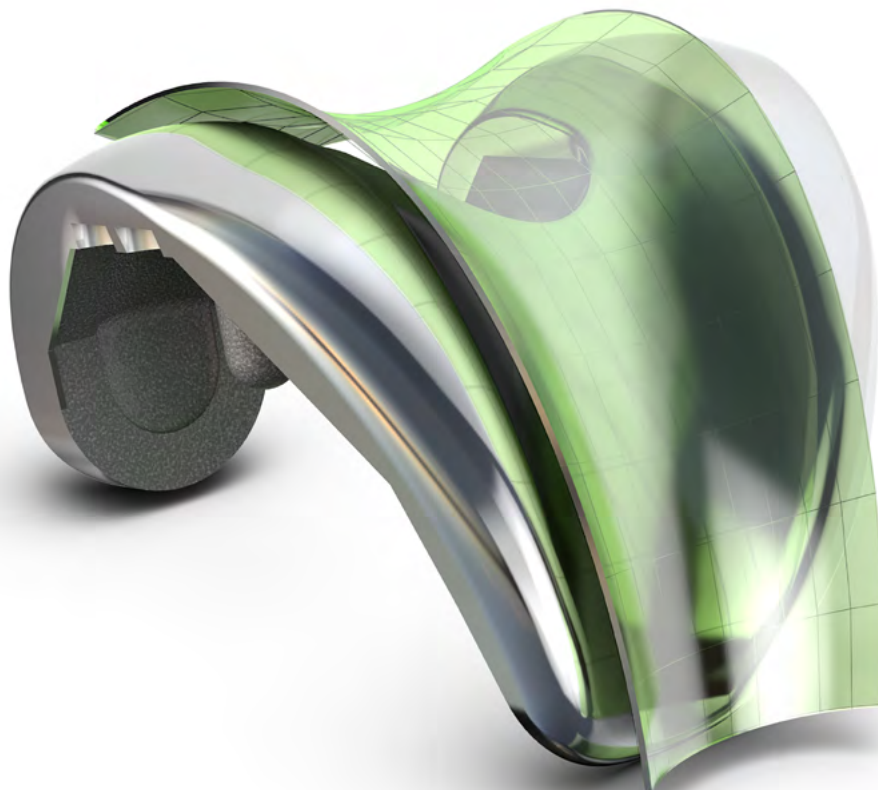

## 2 Extramedullary Alignment and Tibial Resection

01

### Extramedullary Alignment Guide

The *Tibia Extramedullary Alignment Guide* is secured with a *Headed Pin*  $\text{Ø } 3,15 \times 70 \text{ mm}$  in the intercondylar eminence. The pin is impacted through the guide sleeve of the tibial bracket so that it allows rotation of the instrument. The *Tibia Extramedullary Alignment Guide* is adjusted to the length of the tibia of the specific patient and secured with the **clamping screw**.

### Assembling the *Tibia Extramedullary Alignment Guide*



*Tibia Extramedullary Alignment Guide and Tibial Resection block anatomical*



*Tibia Extramedullary Alignment Guide and Tibial Cutting Block adjustable*

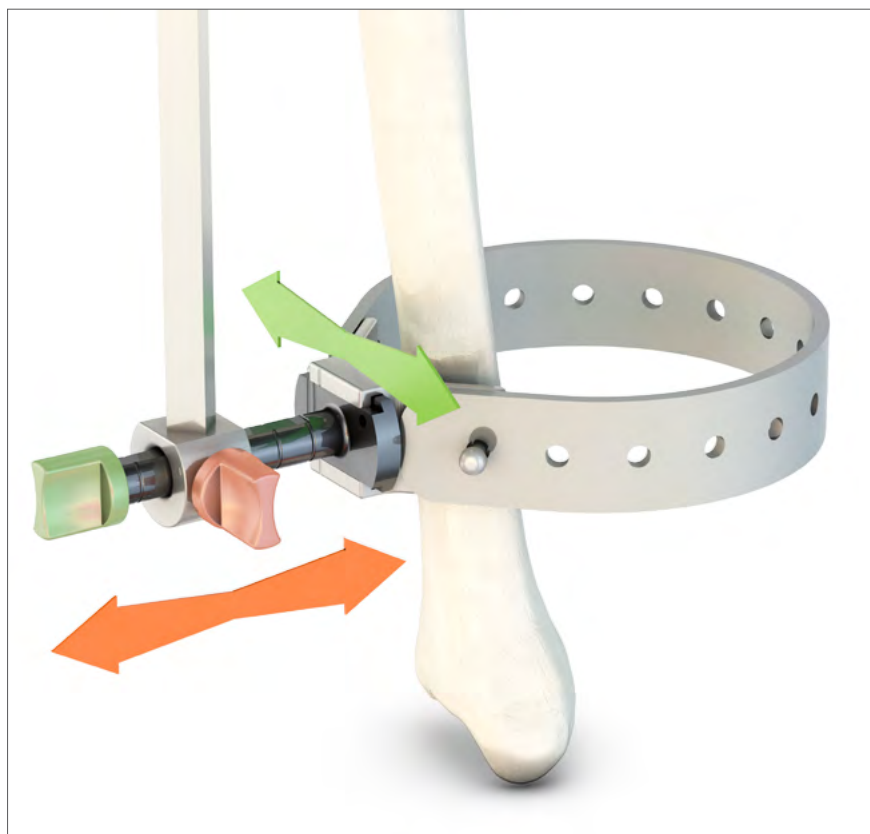

02

### Varus/Valgus and Tibial Slope Adjustments

Varus/valgus and slope adjustments are made with the clamping screws on the lower section of the *Tibia Extramedullary Alignment Guide*.

Posterior Slope

Varus/Valgus

#### ! NOTE

Alignment parallel to the axis of the tibial shaft corresponds to a posterior slope of the tibial plateau of 3°.



## 2 Extramedullary Alignment and Tibial Resection

03

### Assembling the Tibial Resection Depth Guide

The *Tibial Stylus extra long* can be mounted on the *Tibial Resection block anatomic* and *Tibial Cutting Block adjustable*.

#### ! NOTE

The implant system requires a minimal resection of 10 mm to restore the natural anatomy (tibial plateau 3 mm, plus the minimal insert height of 7 mm).

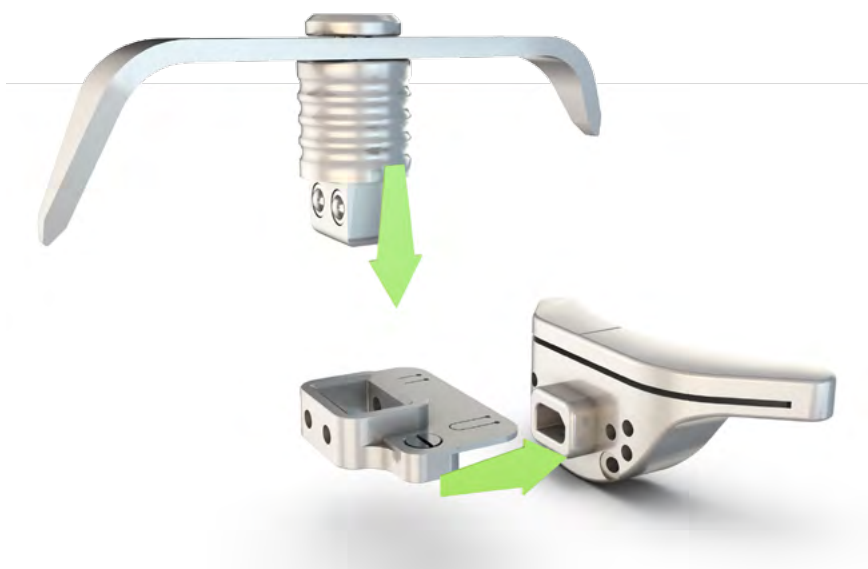

*Tibial Resection block anatomic*

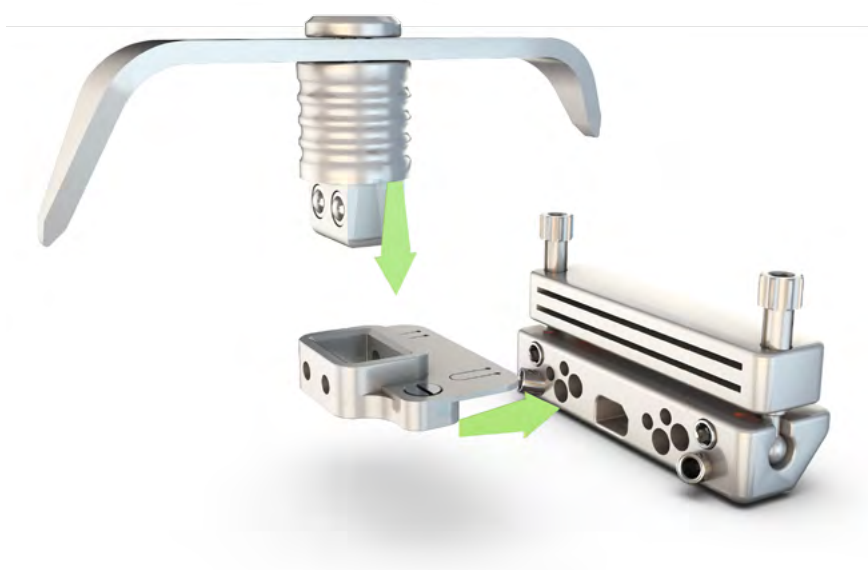

*Tibial Cutting Block adjustable*



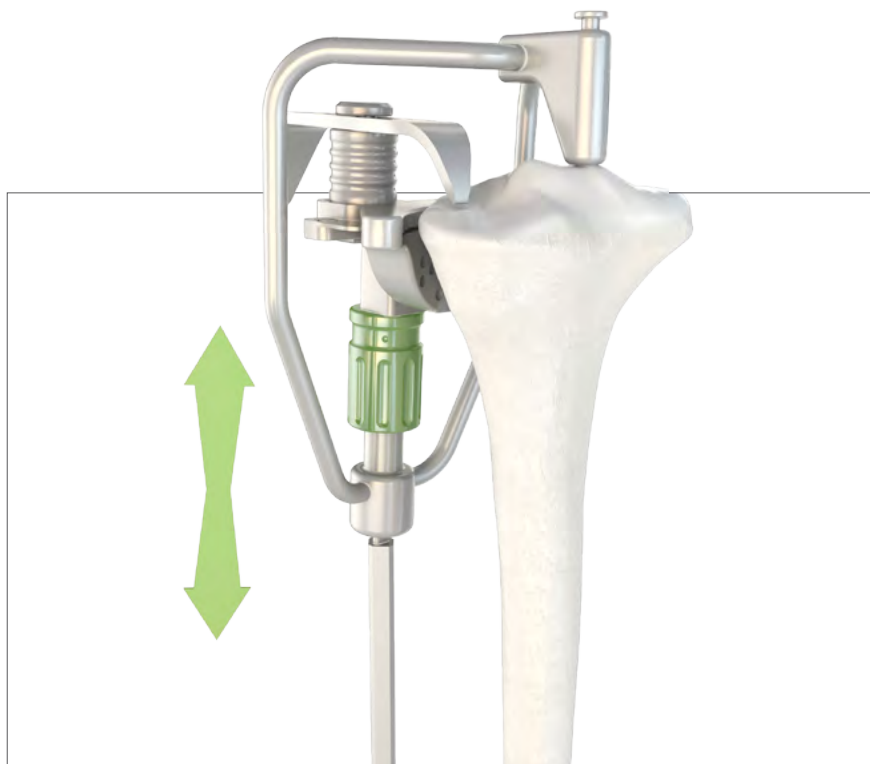

04

Setting the Tibial Resection Depth

After the *Tibial Resection block anatomical* has been attached, the *Tibial Stylus extra long* is lowered to the level of the articular surface with the *adjusting screw*.

! NOTE

One turn of the adjusting screw corresponds to a change in depth of 2 mm.

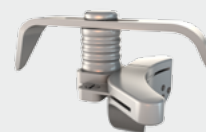

2 mm --- Resection setting --- 10 mm  
 ↓ Side with greater destruction      ↓ Side with lesser destruction



05

Securing the Tibia Extramedullary Alignment Guide

The guide is secured with a *Headed Pin Ø 3,15 x 70 mm*.



06

Checking Resection Depth

The selected resection plane and slope can be checked with the *Visualisation Guide S*.

## 2 Extramedullary Alignment and Tibial Resection

07

### Securing the Tibial Resection or Cutting Block

The *Tibial Resection block anatomic* is secured at the selected resection depth setting with two pins. This requires drilling a pilot hole in the cortex with the *Drill AO Coupling Size: Ø 2,5 mm*. To spare the tendon, the guide should be secured laterally through the patellar ligament with a *Pin with Trocar Ø 3,2 x 85 mm*.

① Adjustments: *Tibial Resection block anatomic*

Moving the resection block  
 $\Delta h = 2.5 \text{ mm}$

Moving the resection block  
 $\Delta h = 5 \text{ mm}$

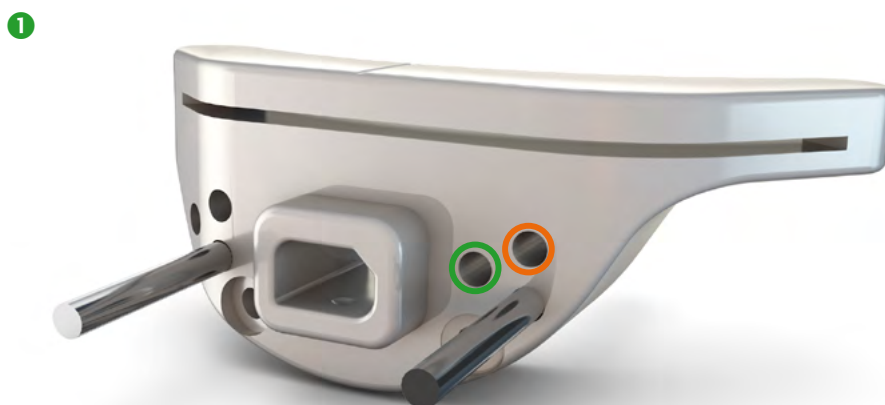

② Adjustments: *Tibial Cutting Block adjustable*

Moving the cutting block  
 $\Delta h = 2.5 \text{ mm}$

#### ! NOTE

Alternatively, the *Tibial Cutting Block adjustable* can be secured with *Screws self-tapping Size: Ø 5 mm*.

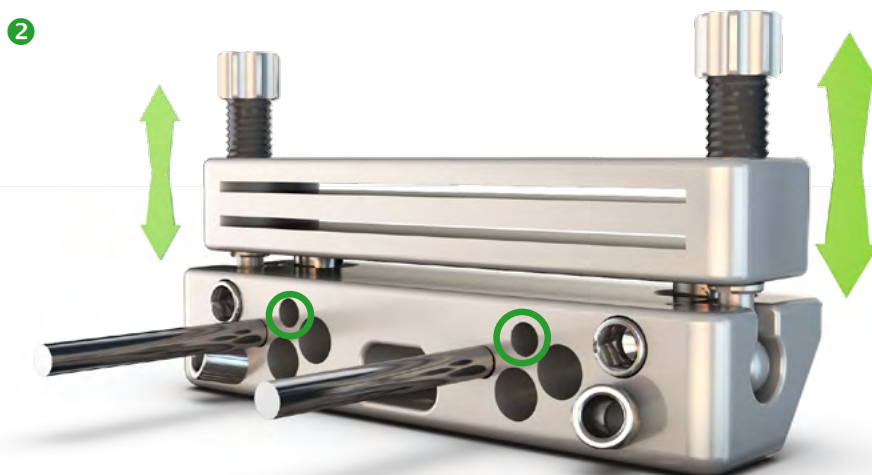



08

### Removing the Tibial Alignment Guide

The *Tibia Extramedullary Alignment Guide* is now removed except for the *Tibial Cutting or Resection Block* which remains in situ. The silicone belt above the ankle is removed. The two *Headed Pins*  $\text{Ø } 3,15 \times 70 \text{ mm}$  must be extracted from the guide sleeve of the tibia bracket using the *Headed Pin Extractor with Slap Hammer*. Then the *Tibia Extramedullary Alignment Guide* is withdrawn from *Tibial Cutting or Resection Block*.

09

### Checking Alignment

Varus or valgus position and rotation of the *Tibial Resection or Cutting block* are again checked with the *Alignment Rod*. When inserted into the selected *Tibial Resection or Cutting block*, the tip of the *Alignment Rod* must point to the anterior margin of the tibia or the extensor hallucis longus, respectively.

## 2 Extramedullary Alignment and Tibial Resection

10

### Correcting Tibial Alignment

If the tip of the *Alignment Rod* does not point to the extensor hallucis longus, the line of the resection can be corrected with the *Tibial Cutting Block adjustable*.

The *Tibial Cutting Block adjustable* is adjusted to correctly transfer the resection depth of the *Tibial Resection block anatomic*. To do this, the *Spacer 7 mm* is inserted into the *Tibial Cutting Block adjustable*. The adjustable section is then lowered onto the *Spacer 7 mm* with the adjustment screws.

#### ! NOTE

Turn the left and right screws alternately to avoid jamming the mechanism.

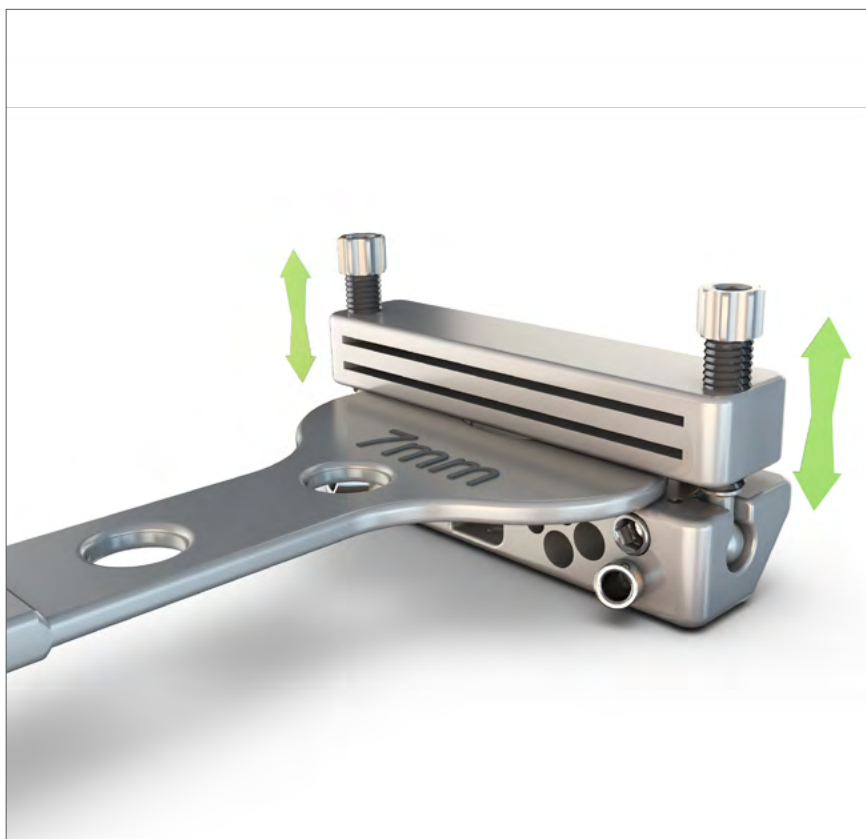

#### ! NOTE

When the adjustment is complete, the second resection slot corresponds to the **resection depth** of the *Tibial Resection block anatomic* (when using the **same seating position**).

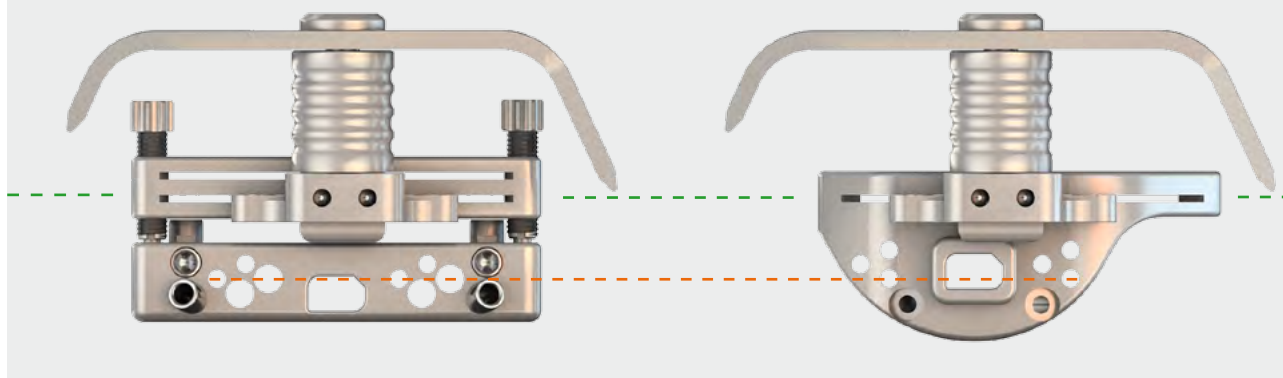



Now the *Tibial Cutting Block adjustable* is slid into position over the *Pin with Trocar*  $\text{\O} 3,2 \times 85 \text{ mm}$ . The same pilot holes as before must be used again. Then the *Alignment Rod* is inserted and aligned with the second toe using the adjustment screws. Once the desired alignment is achieved, the device is locked in this position.



The **two screws** are then tightened to lock the adjustable alignment of the tibial resection plane.

Now the resection may be performed.

## 2 Extramedullary Alignment and Tibial Resection

11

### Performing the Resection

The *Tibial Resection block anatomic* or the *Tibial Cutting Block adjustable* is removed after the tibial resection has been made. The *Pins with Trocar*  $\varnothing 3,2 \times 85 \text{ mm}$  or the *Screws self-tapping* Size:  $\varnothing 5 \text{ mm}$  are left in situ for possible additional adjustments in later stage of the surgery.

### ! NOTE

Please use only PETER BREHM saw blades. The thickness of the saw blades is  $1.18 \pm 0.01 \text{ mm}$ .

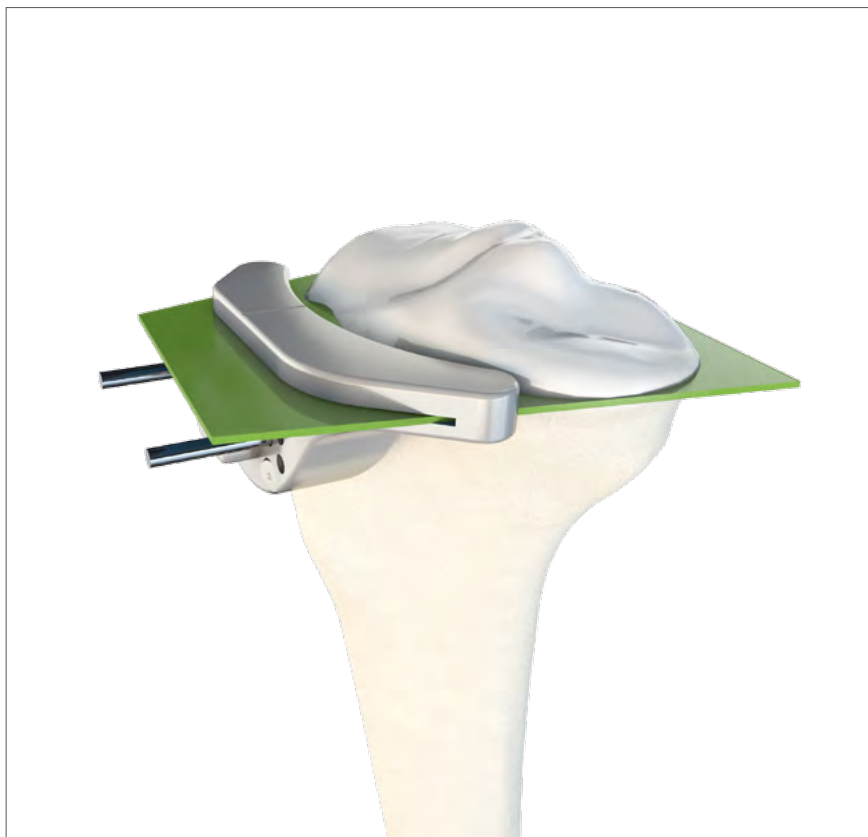

*Tibial Resection block anatomic*



*Tibial Cutting Block adjustable*

### 3 Preparing the Femur

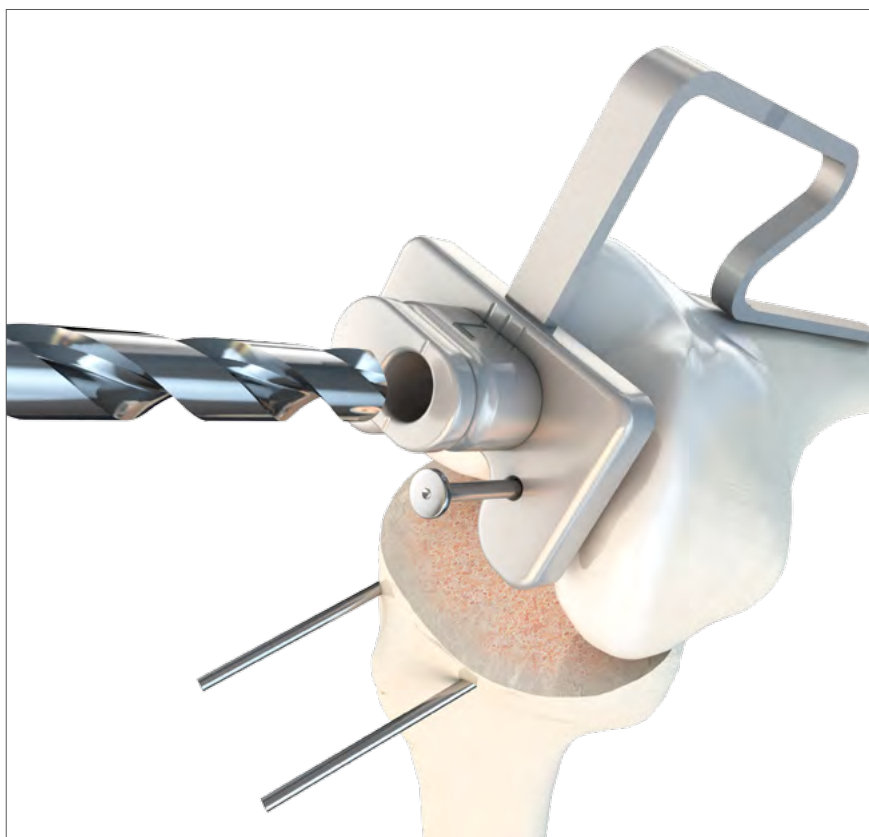

12

#### Preparing the Intramedullary Guide

The point of entry is determined using the *Femoral Drill Guide*. The narrow part of the guide is placed on the distal femur and the plate is centered in the intercondylar notch and secured with a *Headed Pin*  $\varnothing 3,15 \times 30$  mm. Then the medullary canal is broached and reamed as far as the marking on the *Drill for Intermedullary Guide Size:  $\varnothing 11$  mm*.

#### ! NOTE

- | The *Drill Sleeve for Femoral Drill Guide* must be placed in the *Femoral Drill Guide* so that the correct marking is on top (L = left and R = right).
- | The drill hole is checked against anatomic landmarks.
- | Be sure to use the proper right or left side of the *Drill Sleeve for Femoral Drill Guide*.



13

#### Assembling and Inserting the Intramedullary Guide

The **push button** on the *T-Handle Intramedullary Guide* must be depressed when assembling the guide.

#### ! NOTE

The *Intramedullary Guide* is available in 120 mm, 220 mm, and 320 mm lengths.



### 3 Preparing the Femur

The *Intramedullary Guide* is inserted with the *T-Handle Intramedullary Guide* as far as possible.

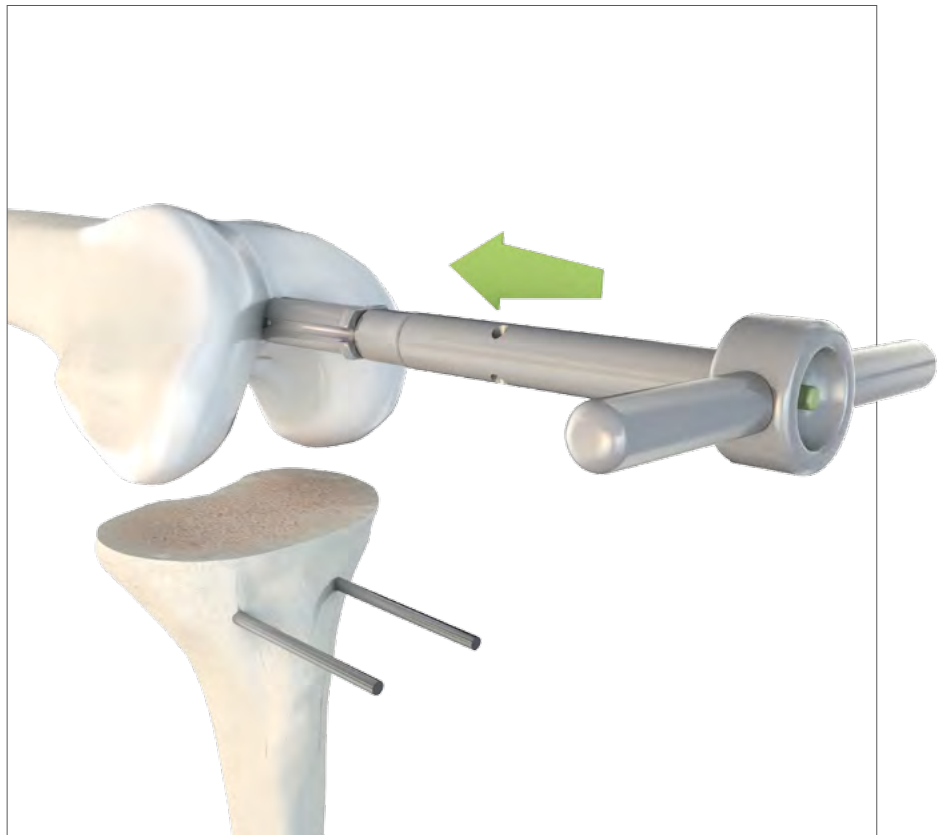

14

Determining the Approximate Size of the Femoral Component  
The *Femoral Sizing Template* is used to determine the approximate size of the femoral component.



15

**Placing the Valgus Plate**

The preoperatively selected right or left *Valgus Plate* (5°, 6°, 7°, 8°, or 9°) is placed onto the *Intramedullary Guide*. The *Valgus Plate* must be in contact with the bone on at least one side.

**! NOTE**

A preliminary osteotomy should be considered if the distance between the *Valgus Plate* and the femoral condyle is too great. The *Valgus Plate* are supplied in left and right versions.

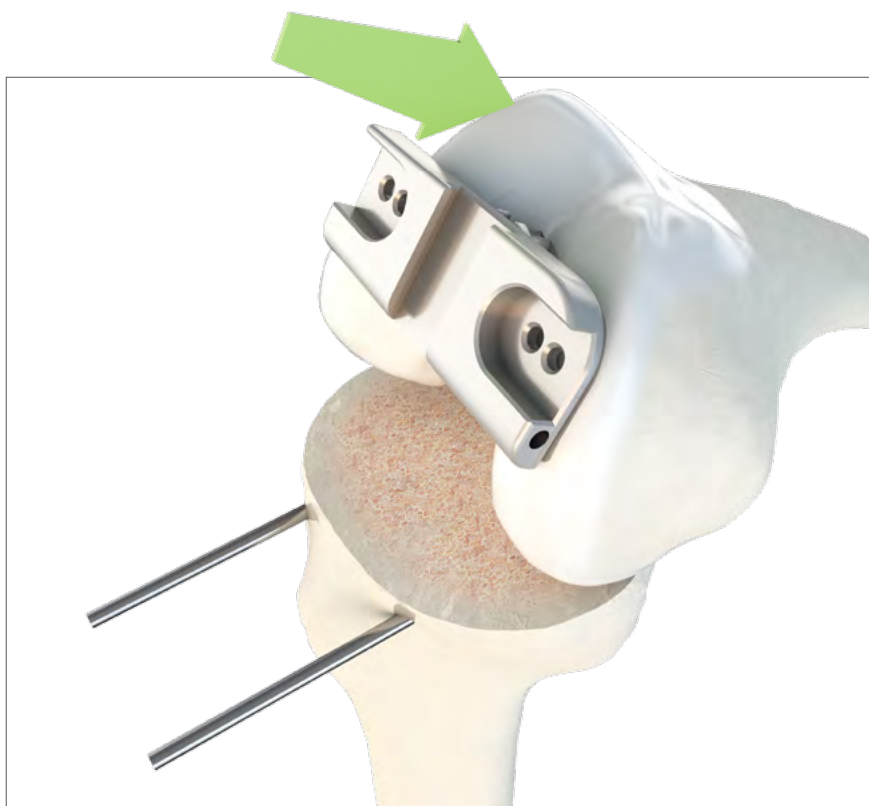

16

**Adjusting Rotation**

The *Flexion Measuring Device* is placed on the *Valgus Plate* to adjust rotation.



### 3 Preparing the Femur

The stylus of the *Flexion Measuring Device* must not be in contact with the bone to allow correction of rotation.

#### ! NOTE

Lock the device with the central clamping screw so that there are about 3-5 mm of clearance between the stylus and the cortex.

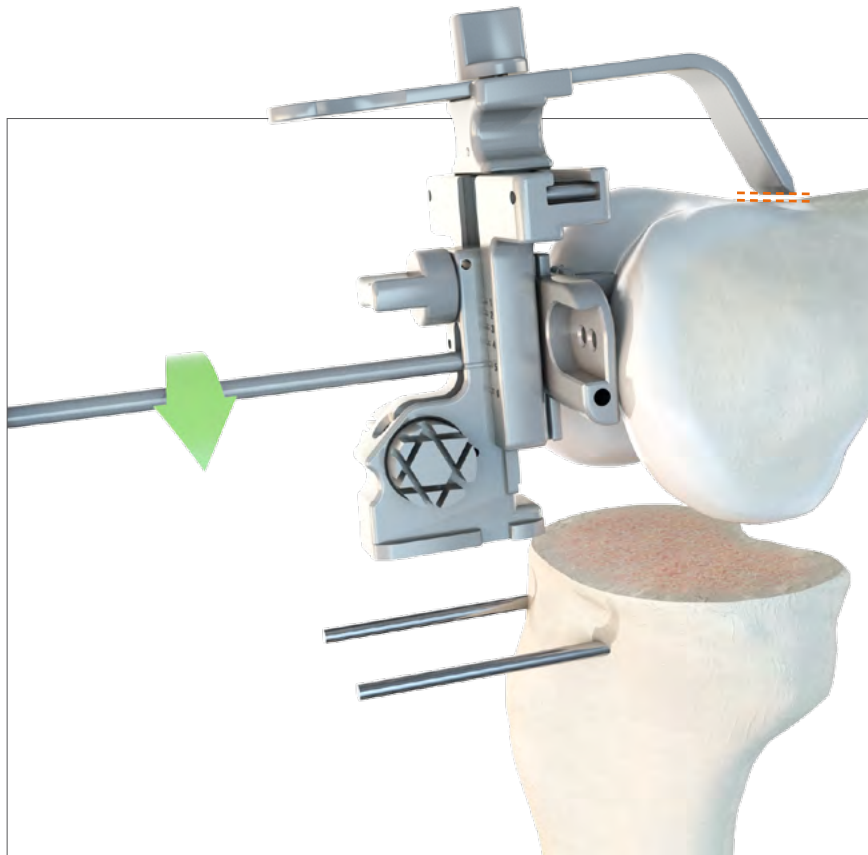

Slide the *Shoe* over the adjustable base with the knee flexed 90°.

#### ! NOTE

The central clamping screw for locking the *Flexion Measuring Device* can only be operated in the adjustable base positions for sizes 3-6.

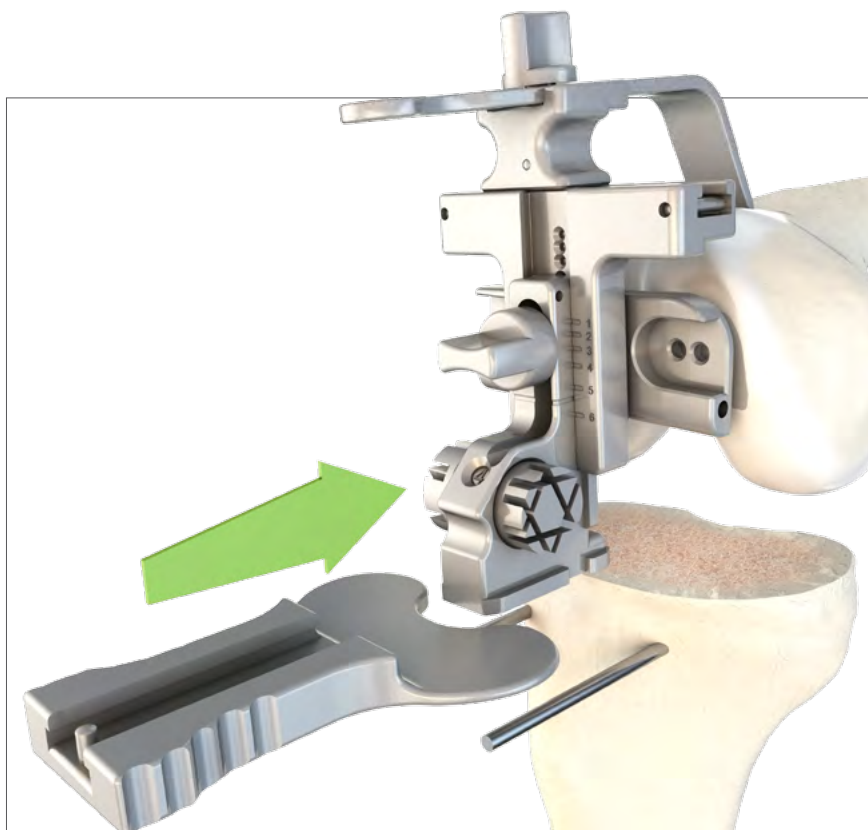

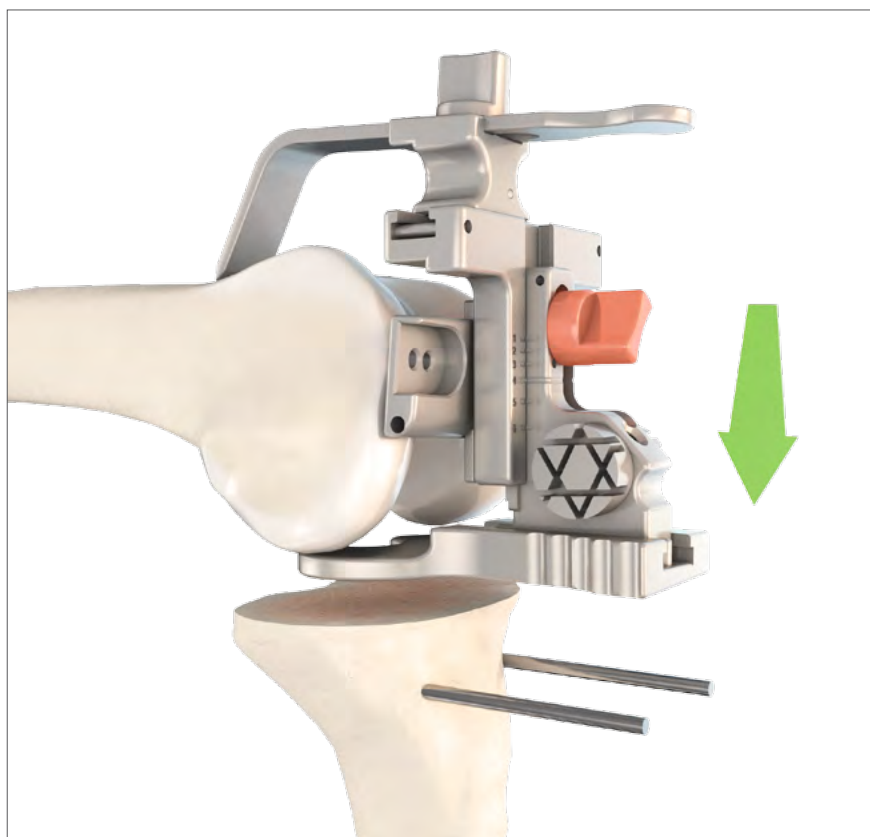

Lower the *Shoe* onto the surface of the tibial osteotomy as far as possible and then secure it with the **clamping screw**.

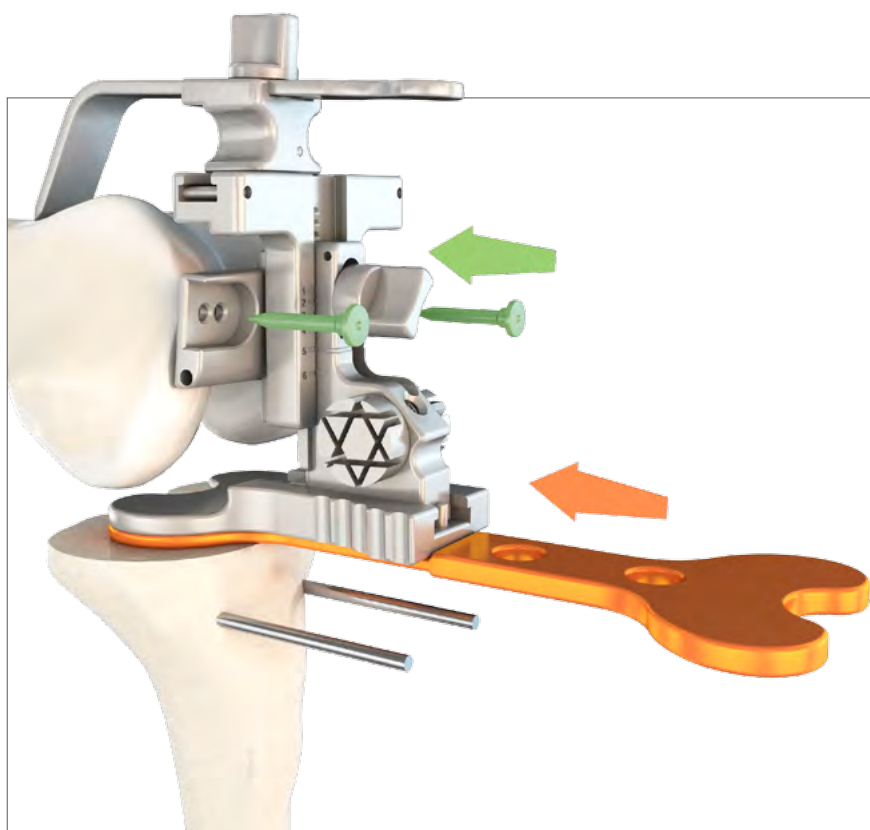

Next the ligaments are tensioned using the various *Spacers*, and anatomic rotational alignment is secured with the aid of two *Headed Pins Ø 3,15 x 30 mm* in the *Valgus Plate*.

### 3 Preparing the Femur

**! NOTE**

Additional alignment options for adjusting the rotation of the valgus plate.

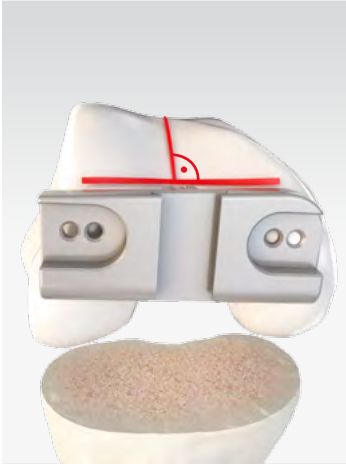

① Whiteside line

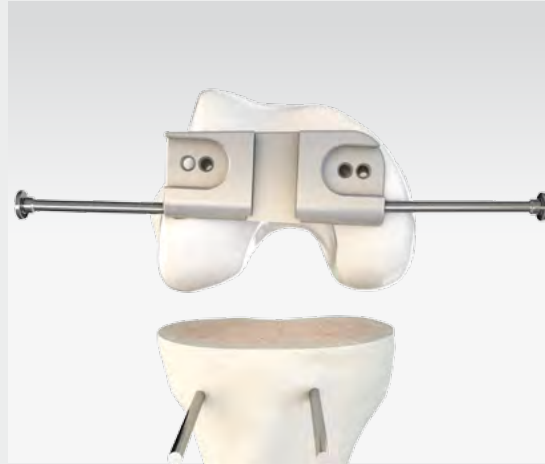

② Epicondylar axis



③ Posterior condyles



17

### Determining the Size of the Femoral Component

- ❶ Set the stylus to the appropriate size, secure it with the **screw**, and lower it to the highest point of the anterolateral cortex.
- ❷ Tighten the **central clamping screw** with the screw driver.
- ❸ Set the adjustable base to the approximate size and secure it with the **clamping screw**.
- ❹ Set the **resection gauge** to the approximate size.
- ❺ Check the posterior osteotomy with the *Visualisation Guide* and set it to the new size if necessary.

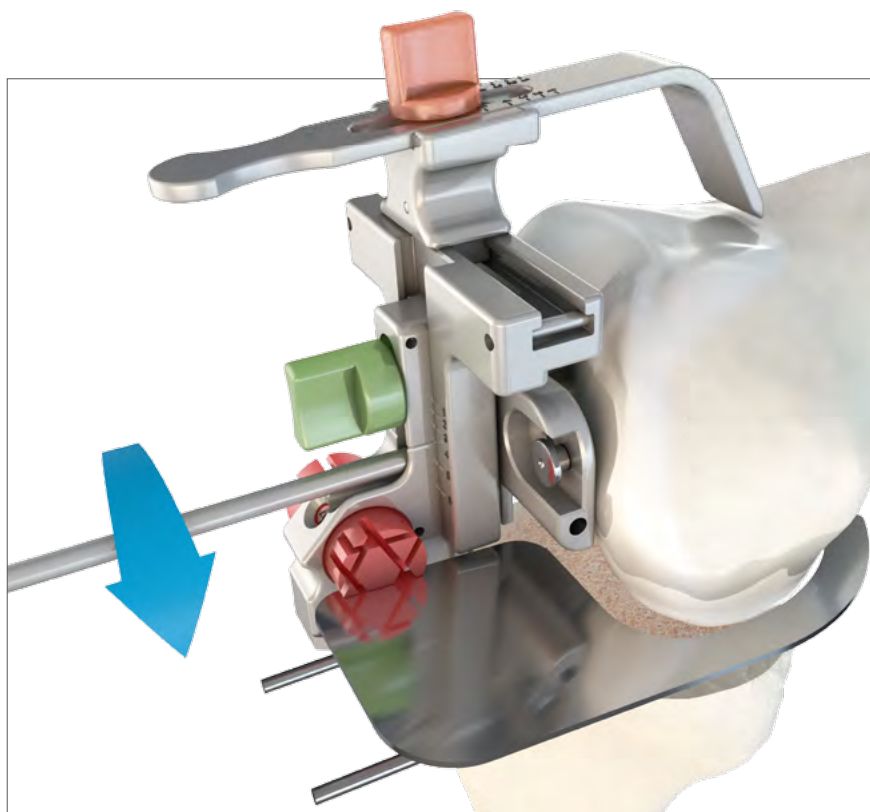

Size adjustment screw on stylus

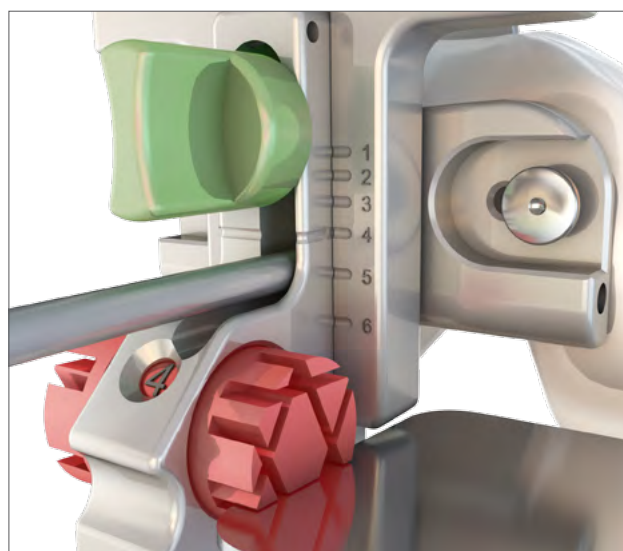

Clamping screw and resection gauge

#### ! NOTE

The central clamping screw for locking the *Flexion Measuring Device* can only be operated in the adjustable base positions for sizes 3-6.

## 4 Checking Flexion and Extension Space

18

### Checking Flexion Space

After checking size, the *Shoe* is again slid over the adjustable base and the *Spacers* (7-17 mm) are used to evaluate flexion space and stability with the knee flexed 90°.

The *Spacers* simulate the height of the definitive polyethylene insert.

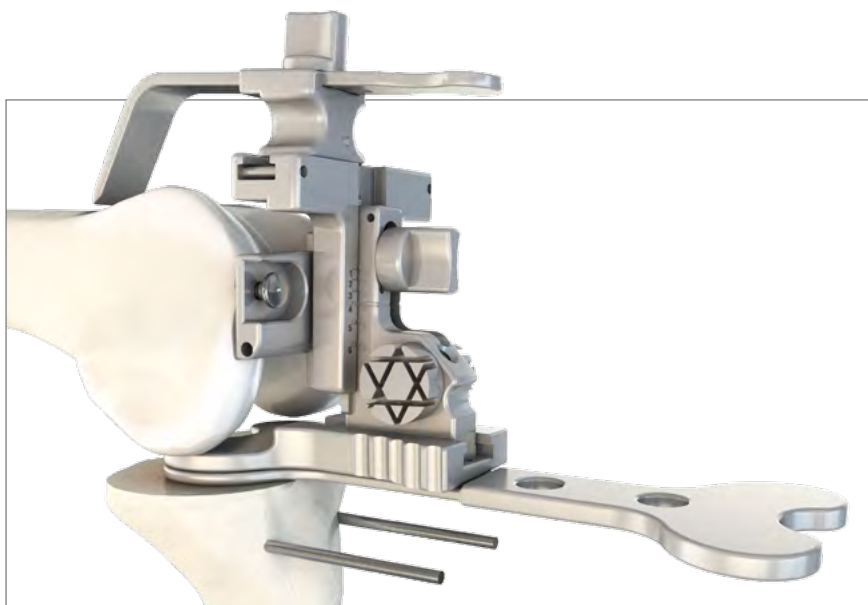

19

### Checking Extension Space

Once the *Flexion Measuring Device* has been withdrawn, the *Spacer* (7-17 mm) is used to evaluate extension space.

#### ! NOTE

Adjusting flexion and extension space

Extension space can be adjusted up to  $\pm 4$  mm during the further course of surgery according to the specific femoral resection instrumentation used.

- | If flexion and extension space is too narrow, more bone should be resected from the tibia (see item 07).
- | If only flexion space is too narrow, a smaller femoral component may be considered.

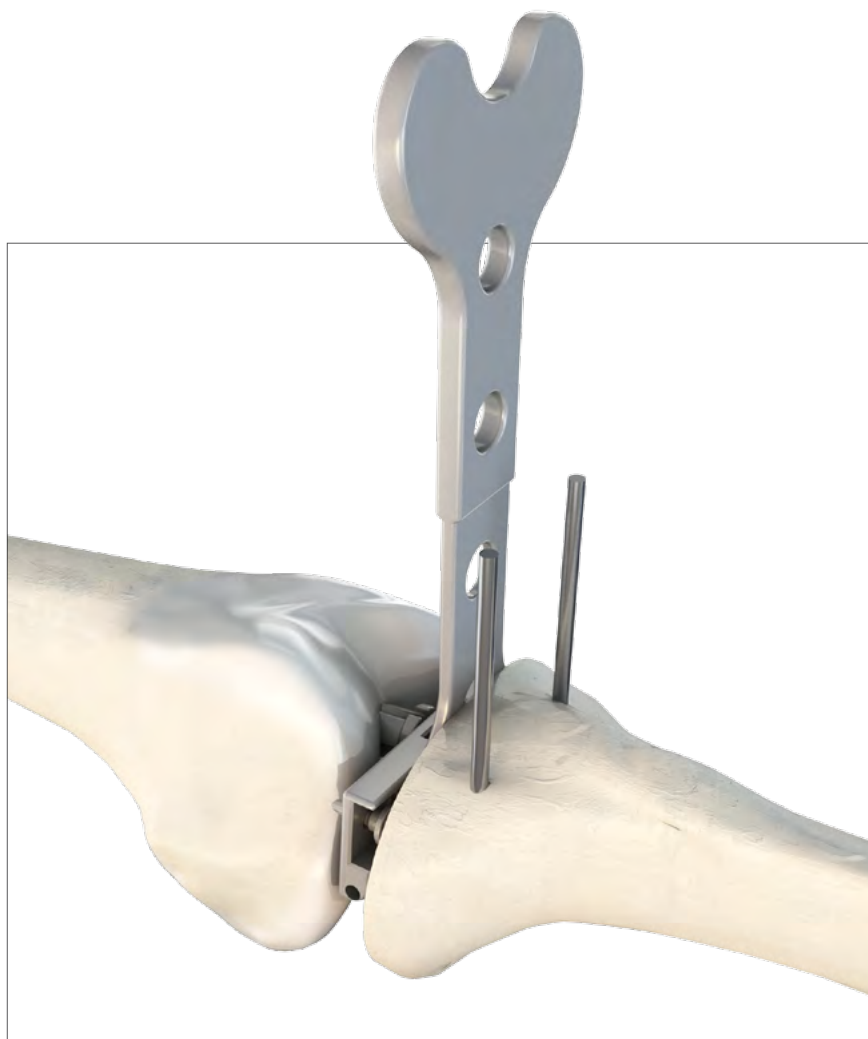



## 5 Femoral Resection

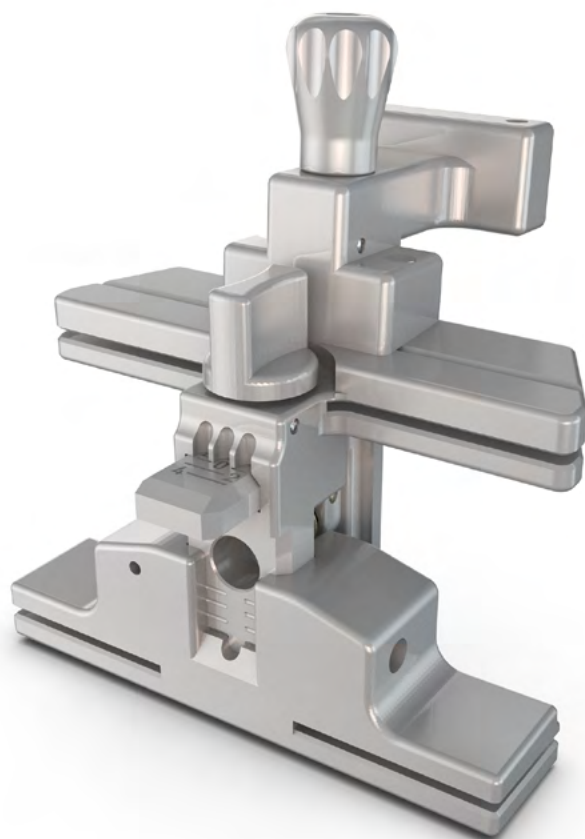

20

Assembling, Attaching, and Aligning the Femoral A/P Resection Guide

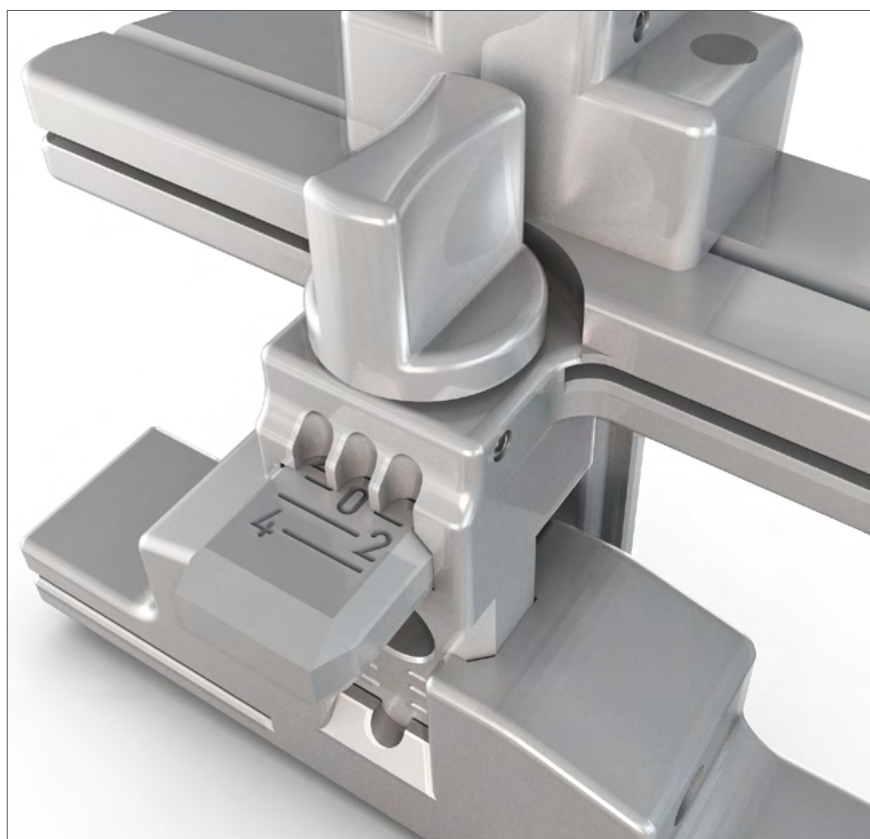

Adjustments on the *Femoral A/P Resection Guide*.

### ! NOTE

Extension space can be widened or narrowed by setting the guide to  $\pm 2$  or  $\pm 4$ .

## 5 Femoral Resection

Set the measured femur size on the *Femoral Stylus* and the posterior resection guide. The settings are secured with the **clamping screw** and **fixation screw**.

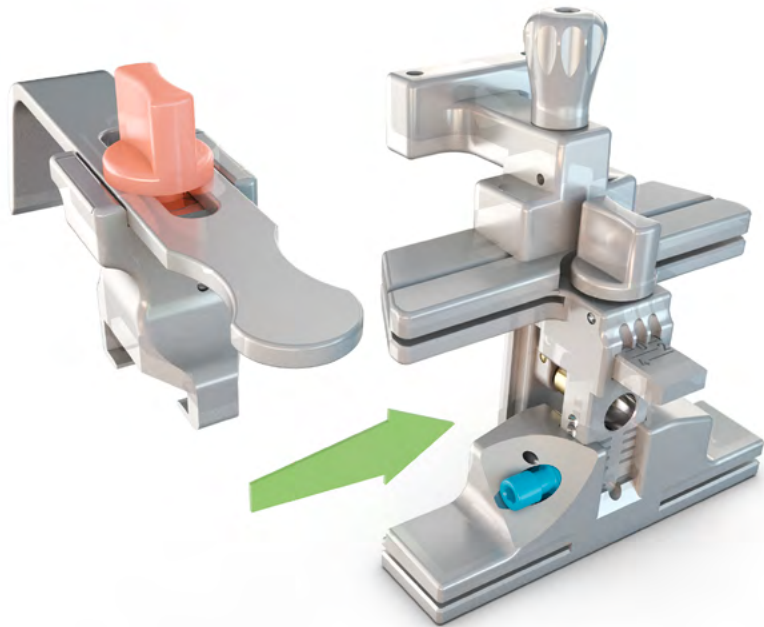

The assembly is placed on the *Valgus Plate*. Lower the *Femoral Stylus* to the highest point of the anterolateral cortex.



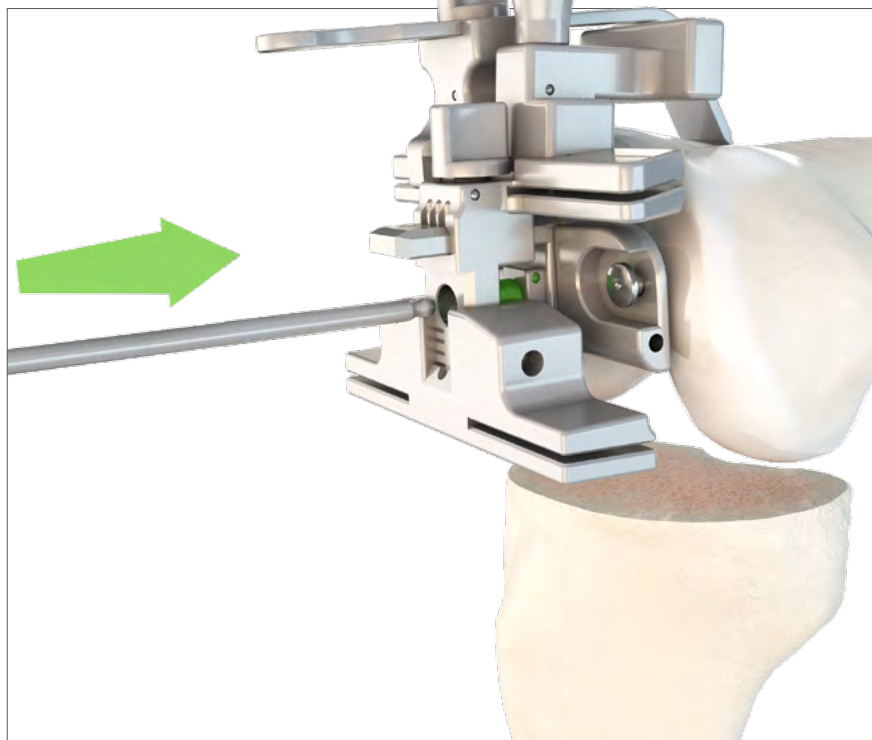

Tighten the **central clamping screw** to secure the assembly.



Check the osteotomy surfaces with the *Visualisation Guide S*.

## 5 Femoral Resection

21

### Performing the Anterior and Posterior Osteotomies

The *Femoral Stylus* is removed and the anterior and posterior osteotomies are performed.

#### ! NOTE

Please use only PETER BREHM saw blades. The thickness of the saw blades is  $1.18 \pm 0.01$  mm.

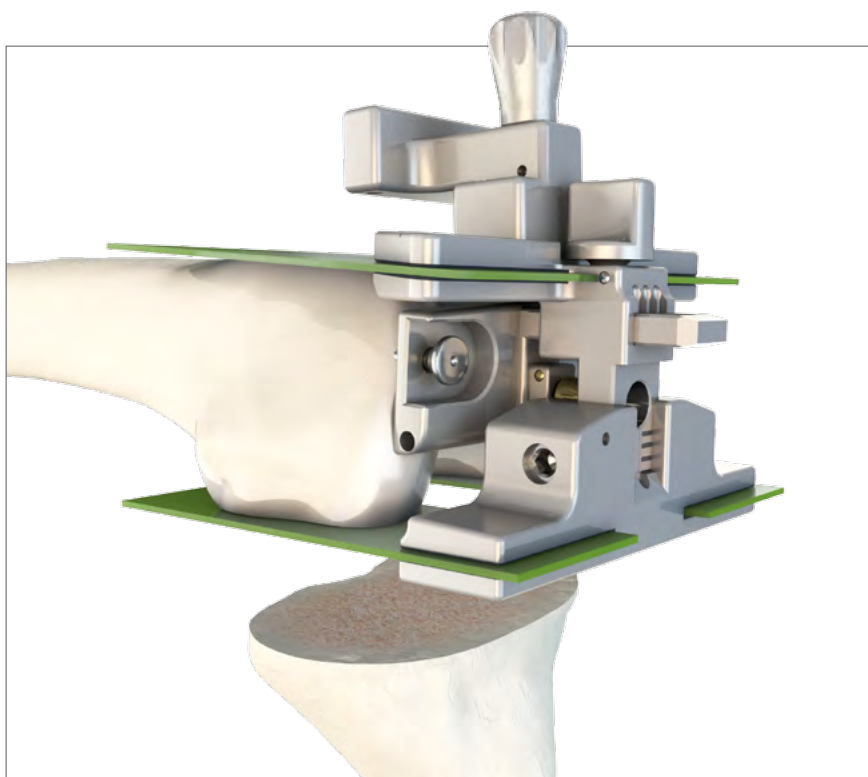

22

### Placing the Pins and Disassembling the Device

Two *Pins with Trocar*  $\varnothing 3,2 \times 85$  mm are inserted through the *Pin Setting Guide*.

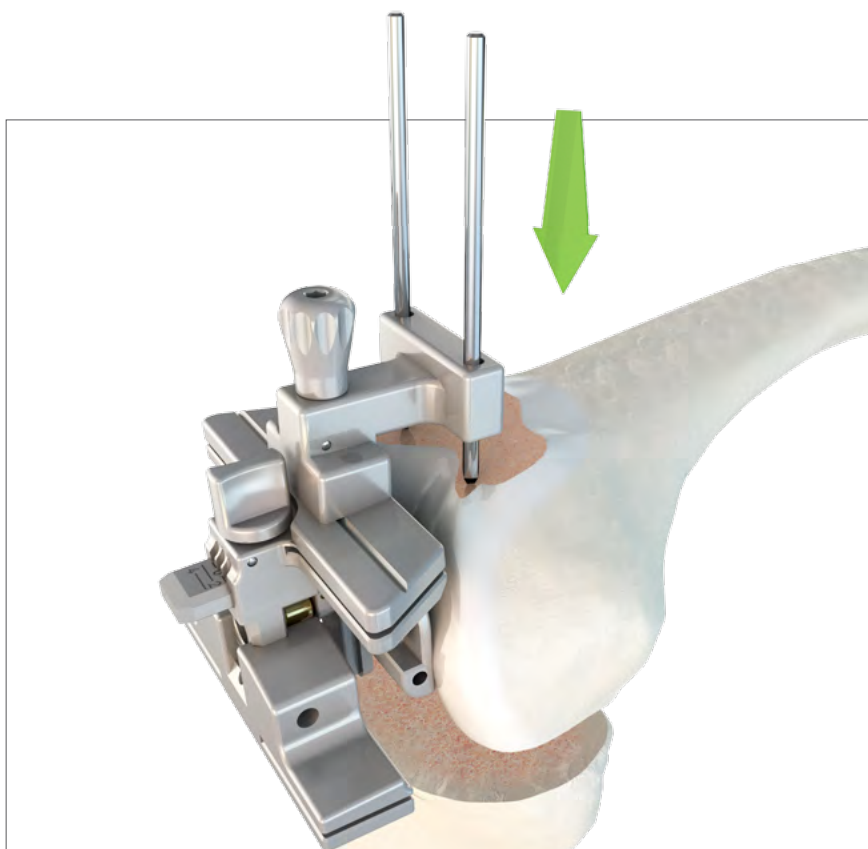

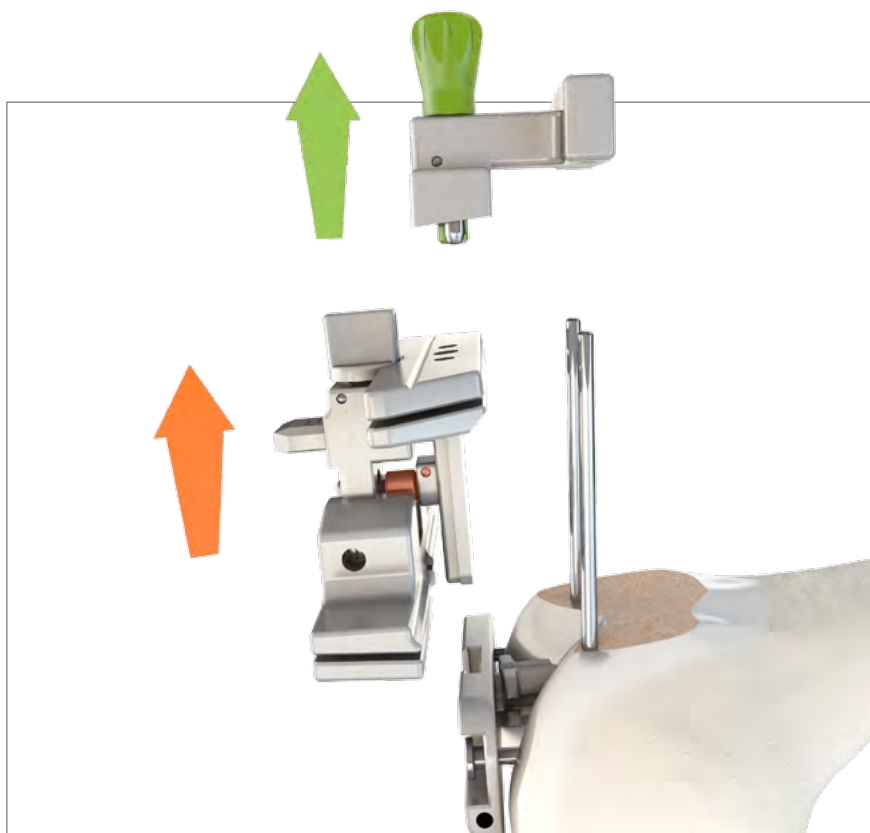

- ① The clamping screw is released and the *Pin Setting guide* is removed.
- ② The central clamping screw is released and the *Femoral A/P Resection Guide* is removed.



- ③ The *Valgus Plate* is removed using the *Headed Pin Extractor with the Slap Hammer*.
- ④ The *Intramedullary Guide* is removed.



## 5 Femoral Resection

23

### Distal Resection

The *Distal Resection Guide* is placed using the drill holes for a neutral osteotomy with the "0" marking. Performing the resection. The *Distal Resection Guide* is secured with pins or handles can be attached to the instrument.



### ! NOTE

Please use only PETER BREHM saw blades. The thickness of the saw blades is  $1.18 \pm 0.01$  mm.

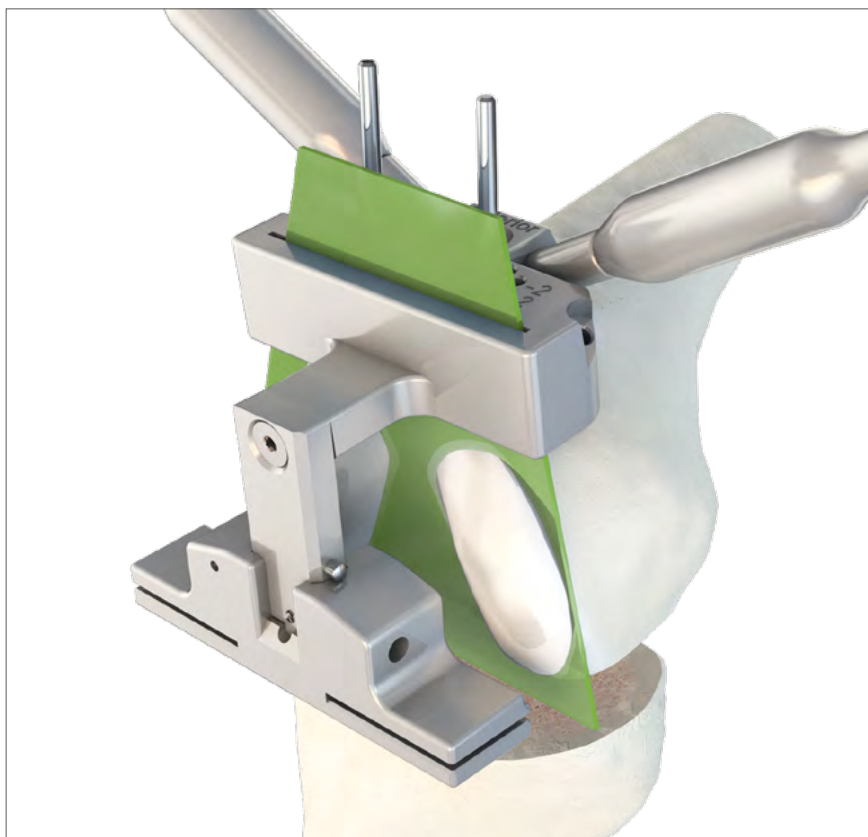



**! NOTE**

The other drill holes can be used to vary the distal resection and thus influence extension space.

A distal resection greater than 0 will require a secondary posterior resection.

Varying the distal resection

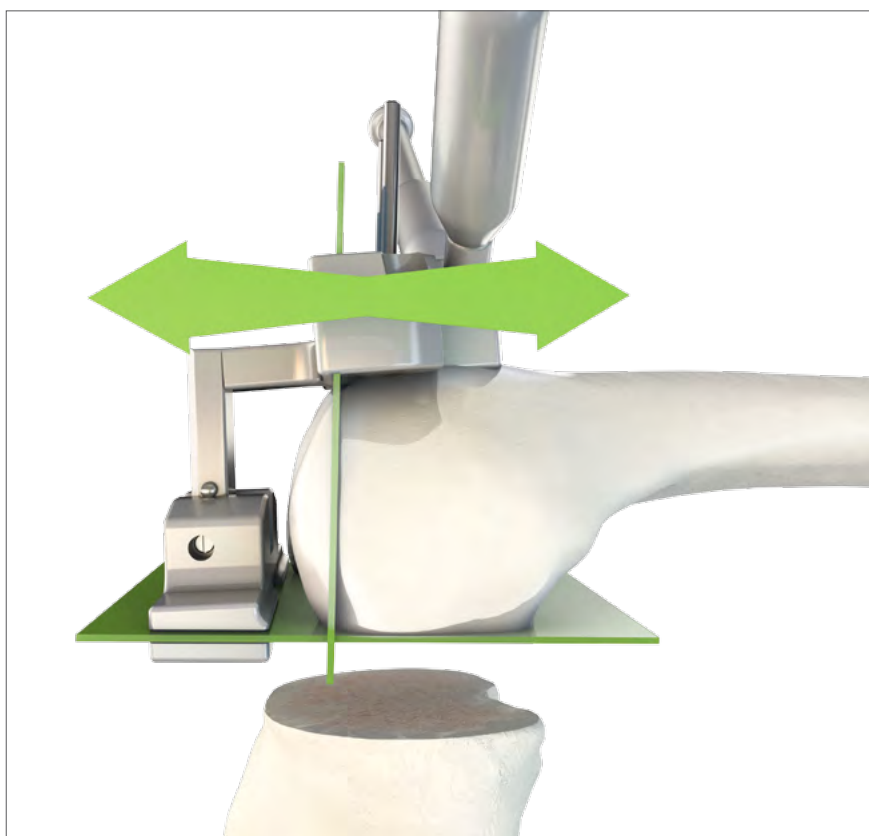

**! NOTE**

The additional *Posterior Resection Guide* is attached and secured laterally with the *Combined Key AF 3,5 / Clamping Screw*.





## 5 Femoral Resection

24

### Rechecking Flexion and Extension Space

After the anterior, posterior, and distal osteotomies have been performed, the surgeon can again use flexion spacers and extension spacers to check flexion and extension space. The height of the *TRIAL Spacer* used is identical to the height of the definitive insert.

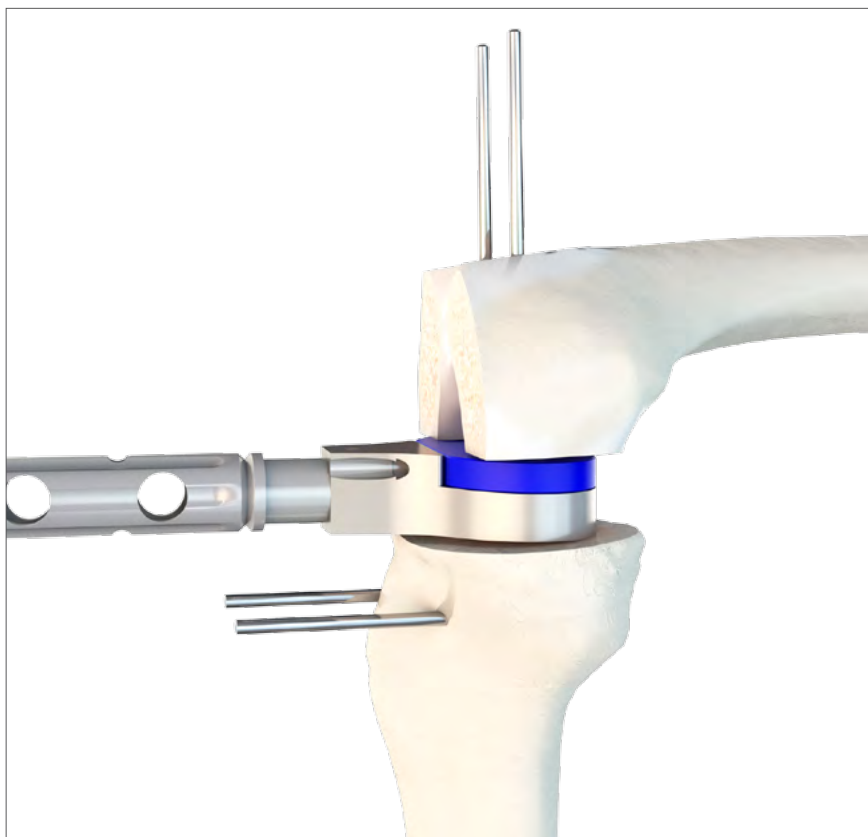
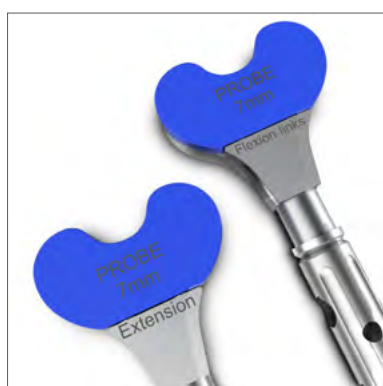

Corrections can still be made if the surgeon now finds that flexion space and extension space vary or extension space is too narrow. This is done using the *Pins with Trocar*  $\varnothing 3,2 \times 85 \text{ mm}$  left in situ in the femur or tibia. For a secondary osteotomy the cutting blocks (*Tibial Cutting* or *Resection block*, *Distal Resection Guide*) are placed at a lower level (see item 07 ff. and item 23).

#### ! NOTE

Verify that you are using the correct spacer labeled „flexion“ or „extension.“

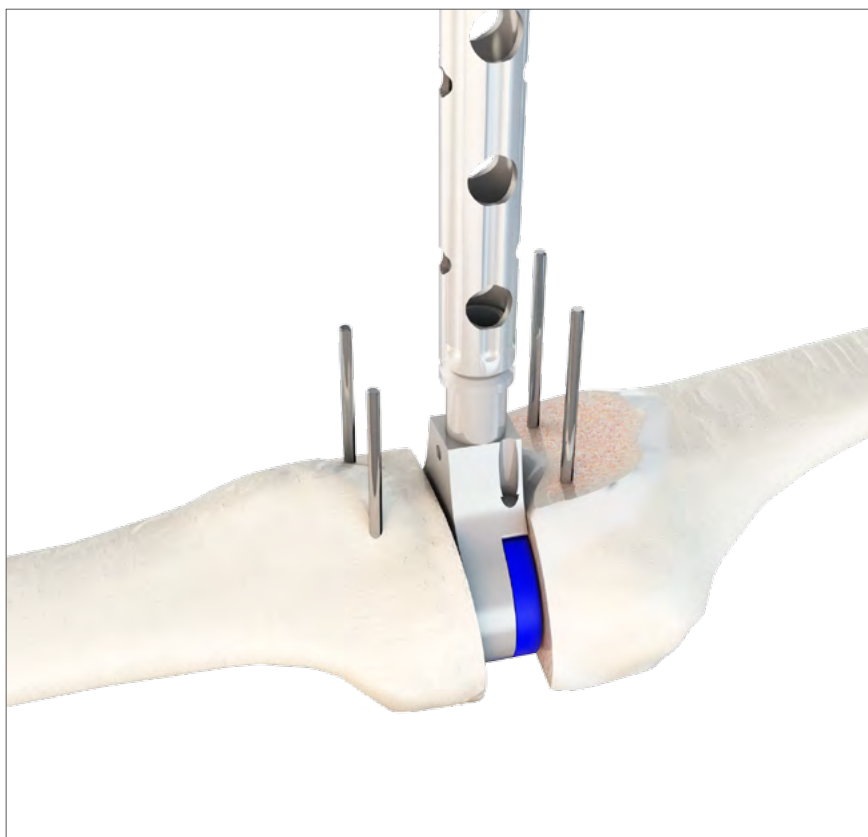

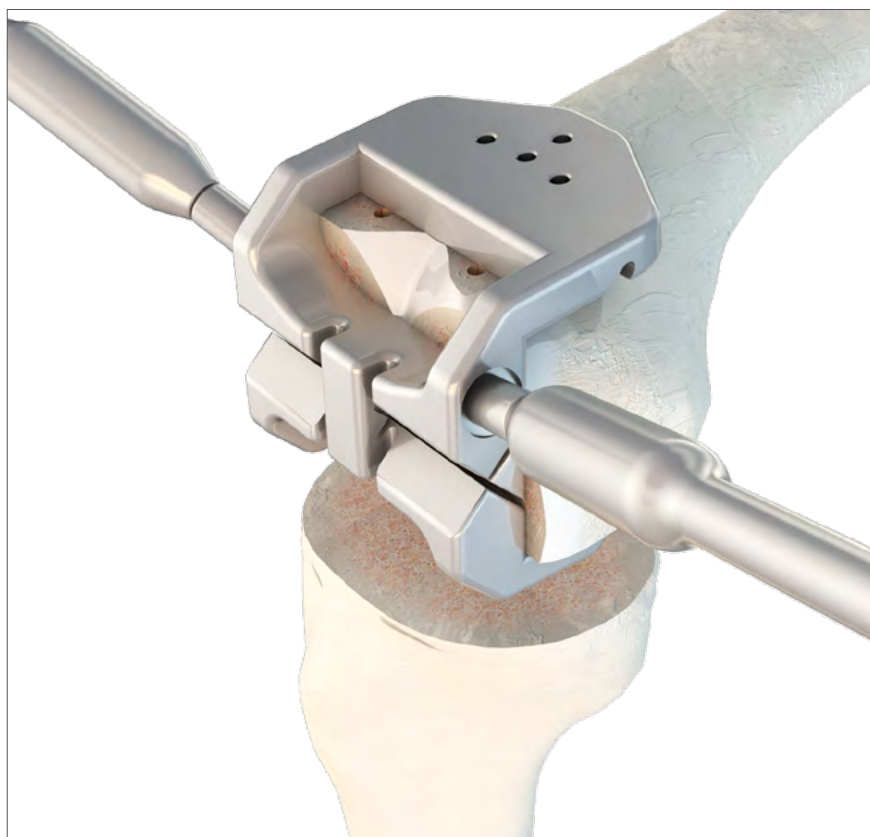

25

### Oblique Osteotomies

After the *Pins with Trocar*  $\varnothing$  3,2 x 85 mm have been removed, the *Chamfer Cut Resection Guide* is placed on the distal osteotomy surface. The *Chamfer Cut Resection Guide* can be secured with handles or pins.



Performing the two oblique osteotomies.

### ! NOTE

Please use only PETER BREHM saw blades. The thickness of the saw blades is  $1.18 \pm 0.01$  mm.

## 6 Tibial Component

26

### Determining the Size of the Tibial Component

The size of the tibial component is determined using the *Tibial Template*. The size that best covers the tibial osteotomy surface is selected. Rotation is also checked using the *Aiming Rod*.

#### ! NOTE

Be sure to use the proper right or left version of the tibial template.



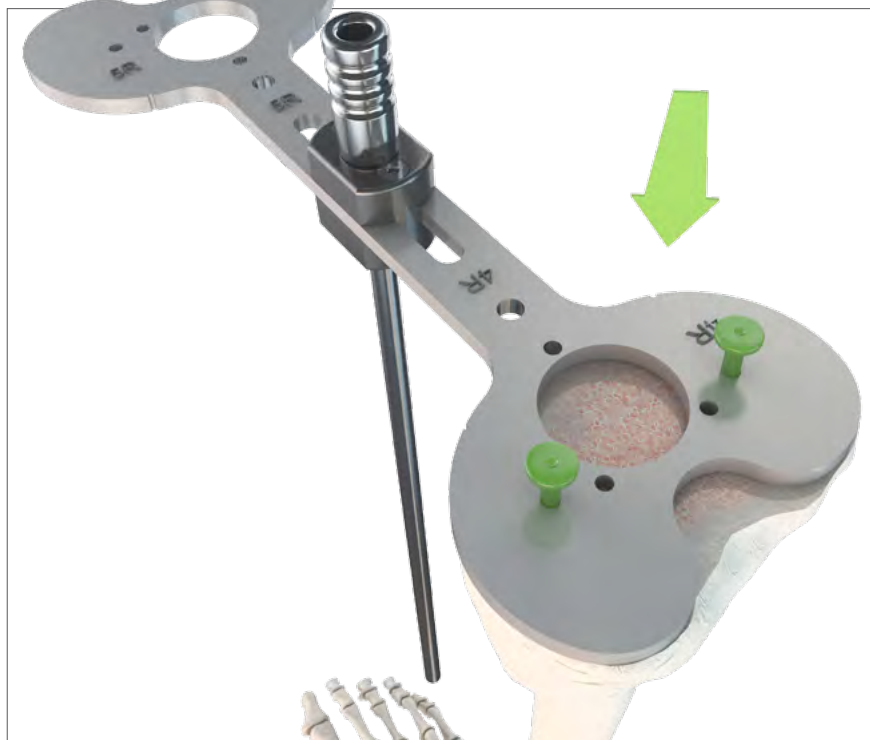

The *Tibial Template* is secured with the *Headed Pins*  $\text{Ø } 3,15 \times 30 \text{ mm}$  in the outer holes.

27

### Resecting Cancellous Bone from the Tibial Head

Attach and secure the *Cancellous Bone Punch Sleeve*. Then cancellous bone is harvested from the tibial head with the *Cancellous Bone Punch*  $\text{Ø } 15 \text{ mm}$ .



## 6 Tibial Component

The tibia is reamed with the *Tibial Cone Reamer* as far as possible. Then the *Tibial Template* and all its attachments are removed.

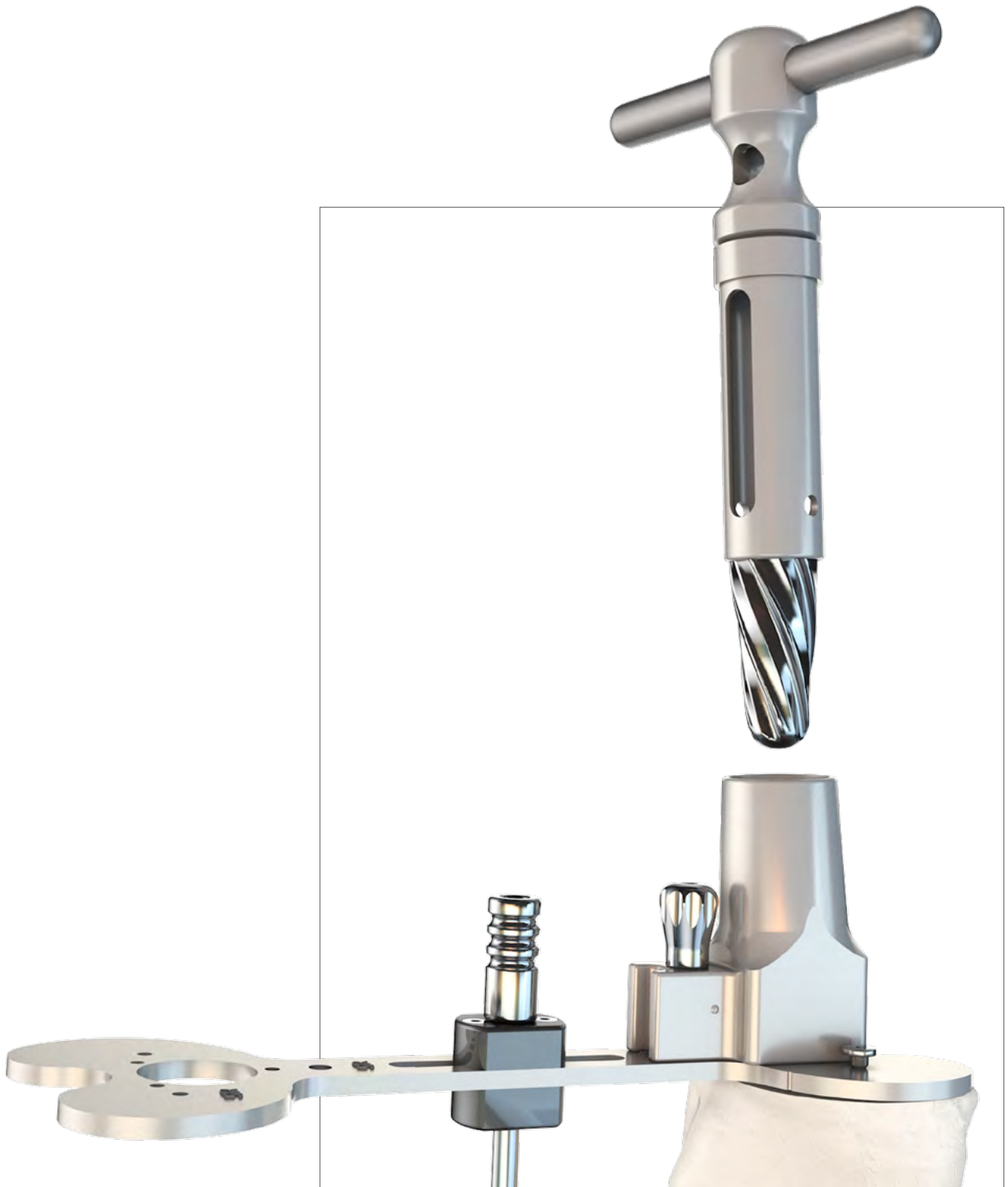

28

Placing the TRIAL TIBIAL Component UC/SC

The TRIAL TIBIAL Component UC/SC of the measured size is implanted with the *Tibial Impactor/Extractor SC*. Press the **central pin** to attach and detach the *Tibial Impactor/Extractor SC*.



## 7 Femoral Component

29

### Sealing the Femoral Canal

The cancellous bone harvested from the tibial head with the *Tibial Cancellous Bone Punch* is now used to close intramedullary femoral canal.



30

Setting the *TRIAL FEMORAL Component UC*.





## 8 Checking and Correcting Rotation of Fixed UC Polyethylene Inserts

31

### Placing the Trial Insert

The size of the *TRIAL INSERT UC mobile* corresponds to the size of the *TRIAL FEMORAL Component UC*. The height is determined by evaluating flexion space and extension space (see chapter 3).

The insert is placed with the *Trial Insert Holder*.

### ! NOTE

Insert size = femur size

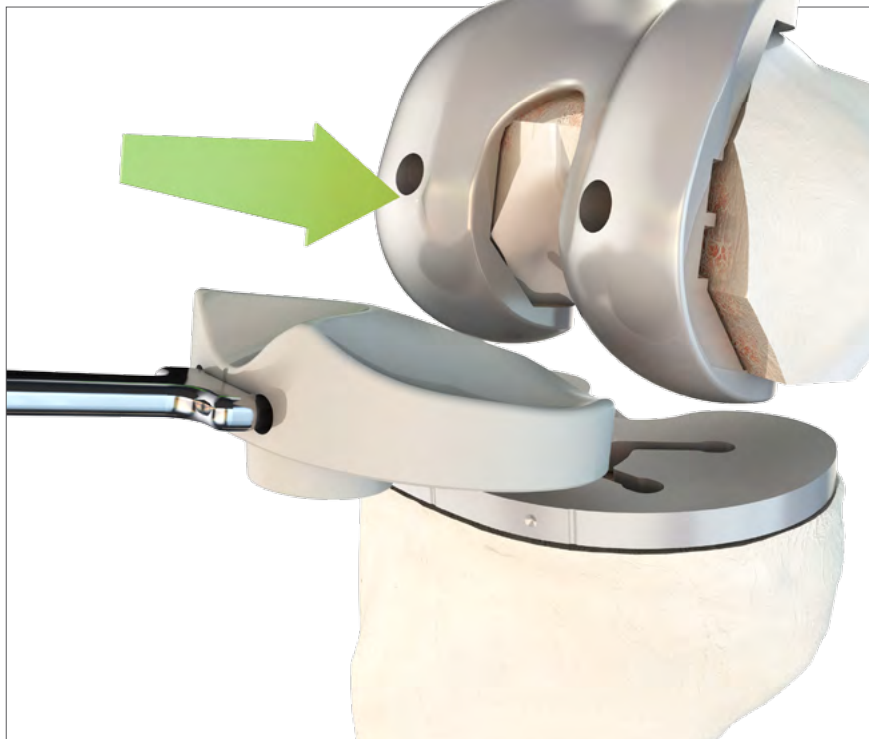

32

### Checking Rotation of the Tibial Component

After the knee is moved through its range of motion several times, the rotation of the *TRIAL INSERT UC mobile* is marked on the anterior tibia.

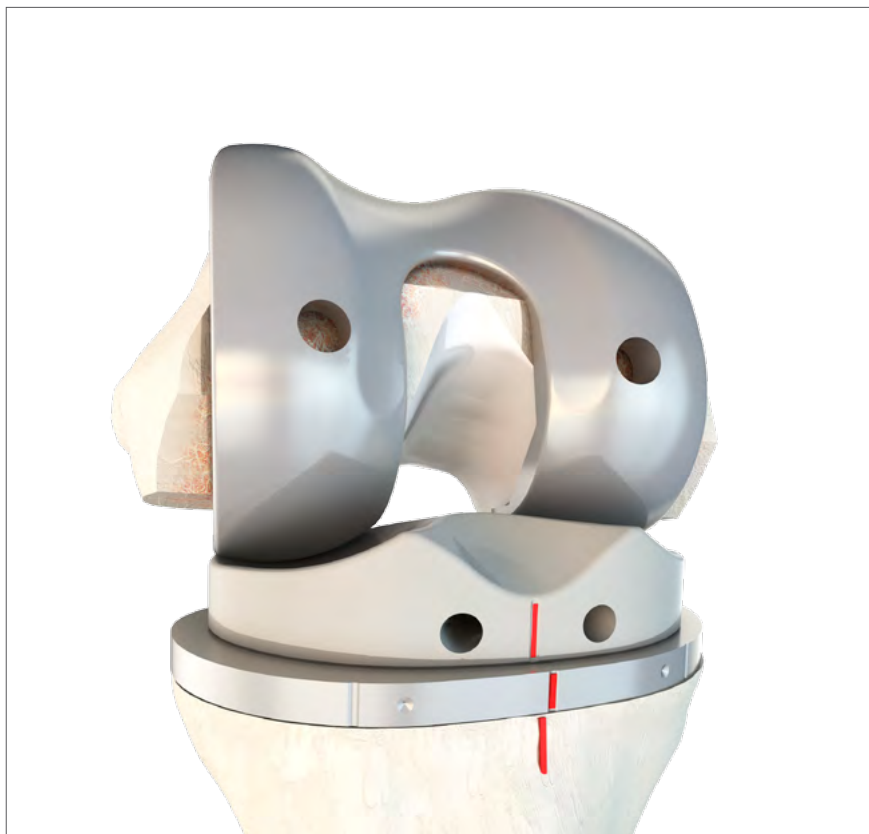

## 8 Checking and Correcting Rotation of Fixed UC Polyethylene Inserts

33

### Correcting Rotation of the Tibial Component

When a fixed insert is used, the *TRIAL TIBIAL Component UC/SC* is rotated on the tibia according to the marking.

#### ! NOTE

Note the possible combinations listed in the appendix.

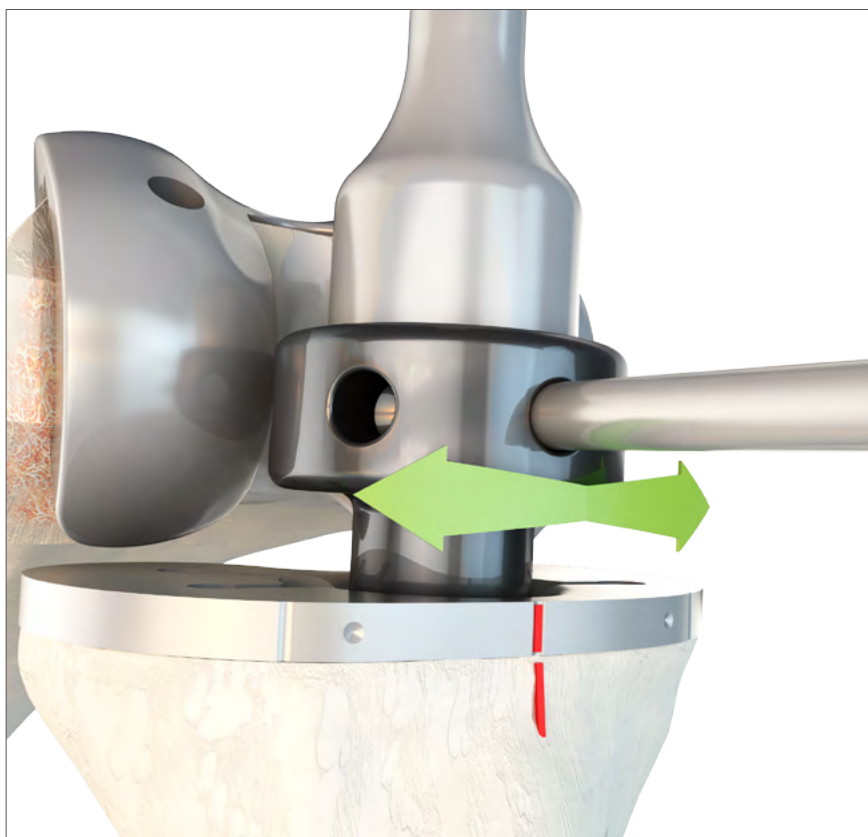

34

### Drilling the Fixation Holes

The holes for the lugs of the femoral component are drilled through the 6 mm holes of the *TRIAL FEMORAL Component UC*. The *Drill for femoral Lugs AO Coupling Size: Ø 6 mm* is used for this.



35

### Impacting the Cancellous Pusher

The cancellous bone is compressed with the *Cancellous Pusher*. A fine drill is used in sclerotic areas. The *Tibial Impactor/Extractor SC* is used to remove *TRIAL TIBIAL Component UC/SC*.

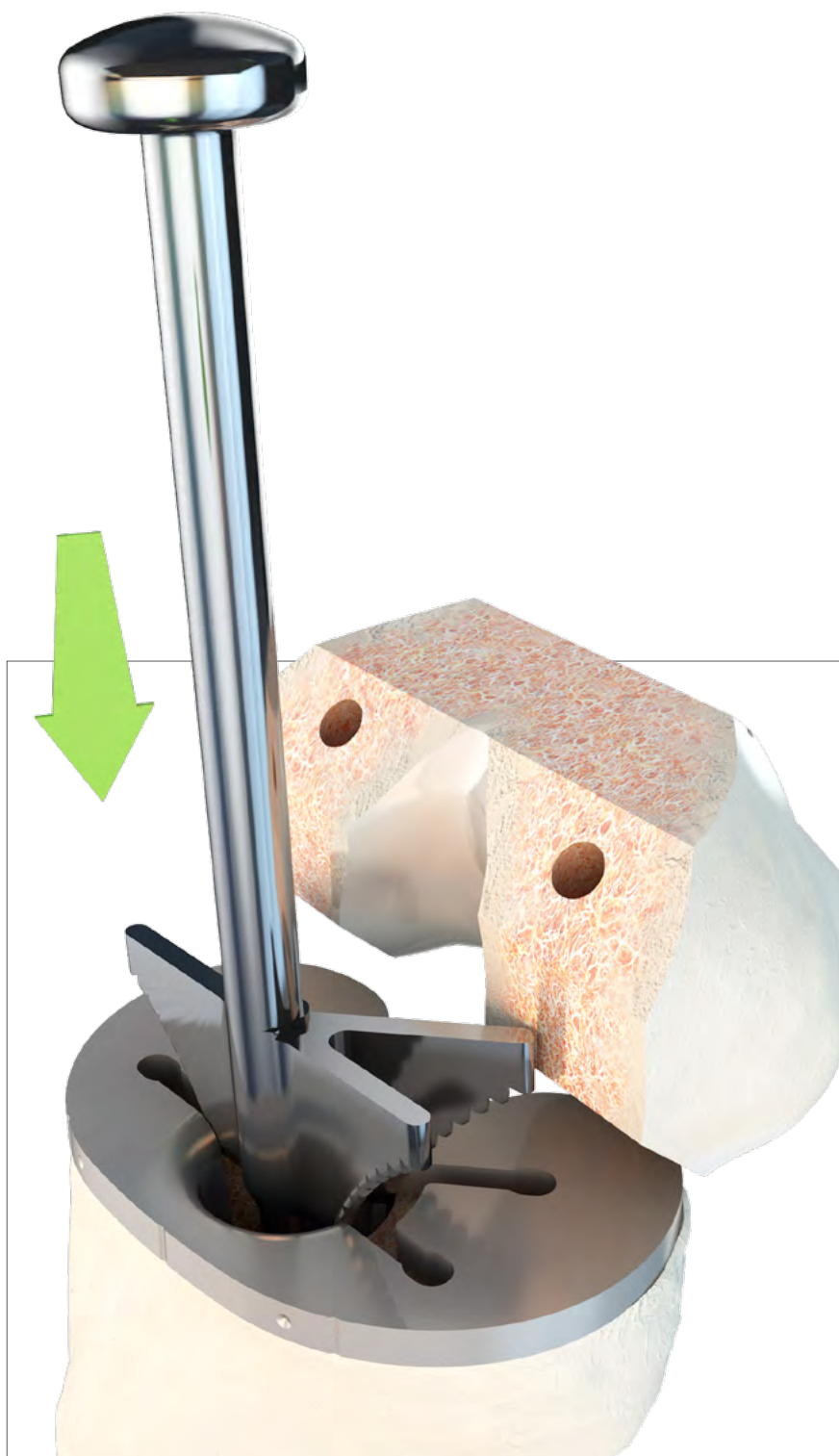

## 9 Placing the Definitive Components

36

### Placing the Definitive Tibial Component

Before the definitive tibial component is placed, it must be sealed with the SEALING SCREW Femur / Tibia UC or UC/SC. There is no sealing screw for the BPK-S Integration Ceramic tibial component.



Placing the tibial component with the *Tibial Impactor/Extractor SC*. Please note that there are separate cemented and cementless versions.

#### ! NOTE

The notes in Appendix A must be closely observed when using the BPK-S Integration Ceramic.

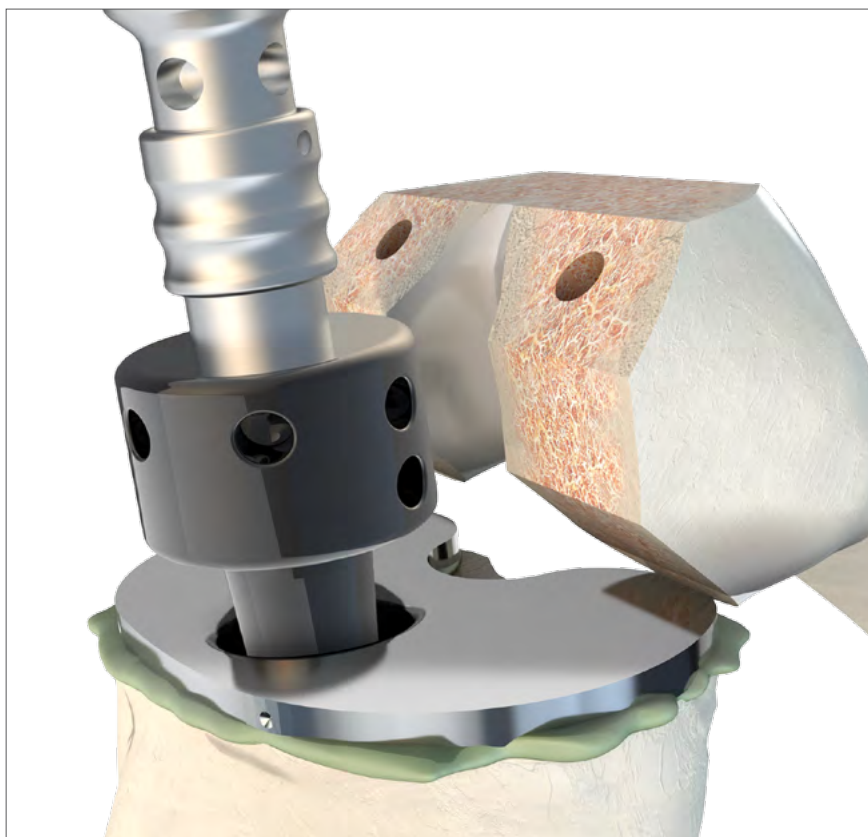



37

### Placing the Definitive Femoral Component

Cemented and cementless versions of the FEMUR Component UC are available.

#### ! NOTE

When impacting the FEMUR Component UC it is important to exert upward pressure with the assembled *Femoral Impactor/Extractor*

#### ! NOTE

The notes in Appendix A must be closely observed when using the BPK-S Integration Ceramic.

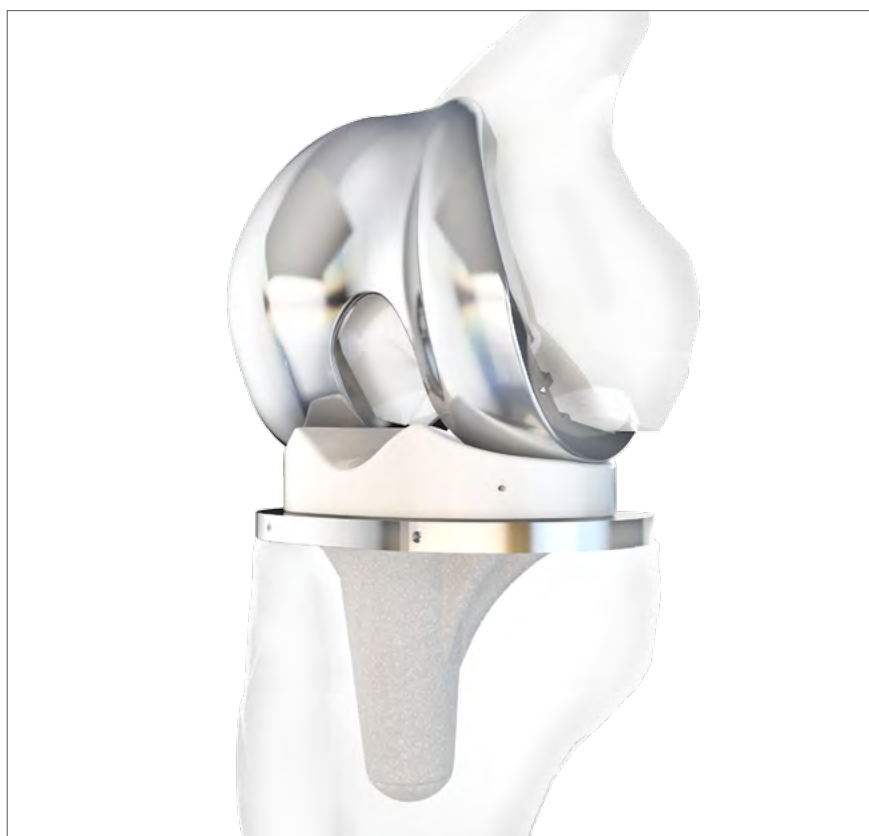

38

### Placing the Definitive PE-Insert UC or DD

The definitive PE-Insert UC or DD is placed once the cement has hardened.

#### ! NOTE

The size of the PE-Insert UC or DD corresponds to the size of the FEMUR Component UC.



## 10 Patella Preparation

39

Preparation and Osteotomy of the Patella

- ① Patella Gripper
- ② Drilling Jig
- ③ Drill for femoral Lugs AO  
Coupling Size: Ø 6 mm
- ④ Patella Chimney
- ⑤ TRIAL Patella Base Plate
- ⑥ TRIAL PATELLA
- ⑦ Cementing Pliers
- ⑧ Original Patella

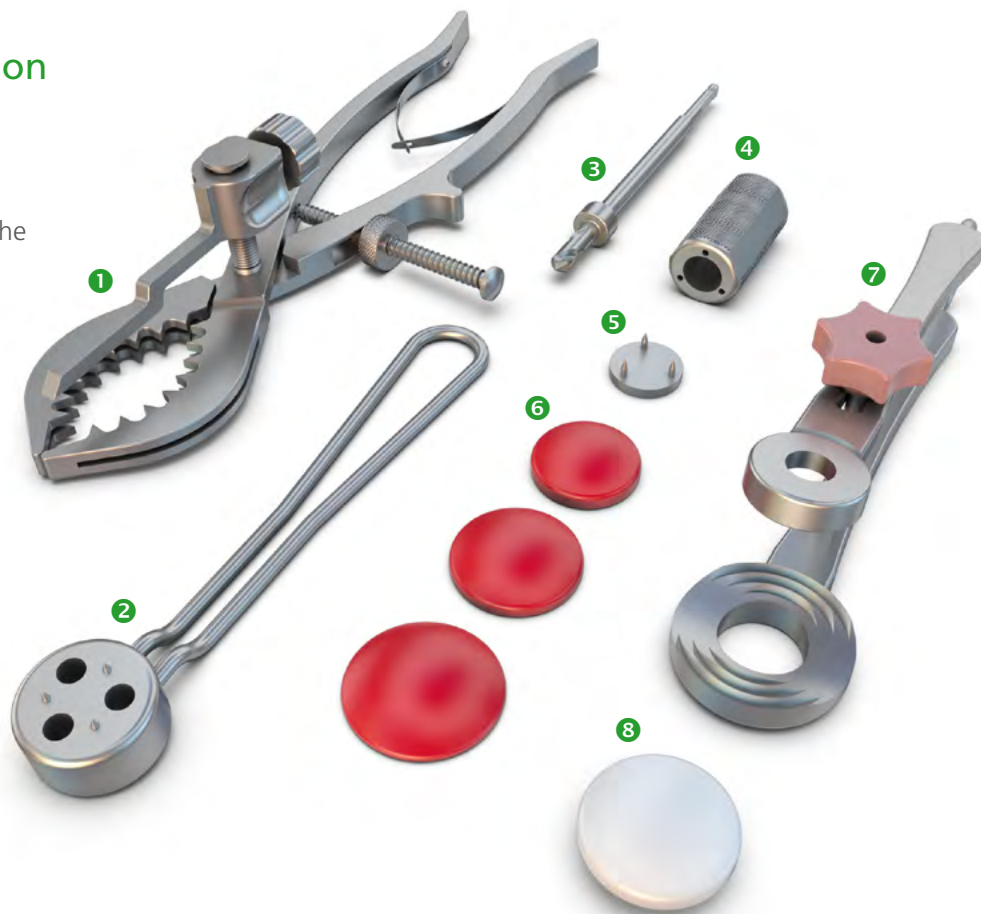

Measuring the thickness of the patella with the *Patella Caliper*. The residual thickness of the patella after resection must be at least 10 mm.

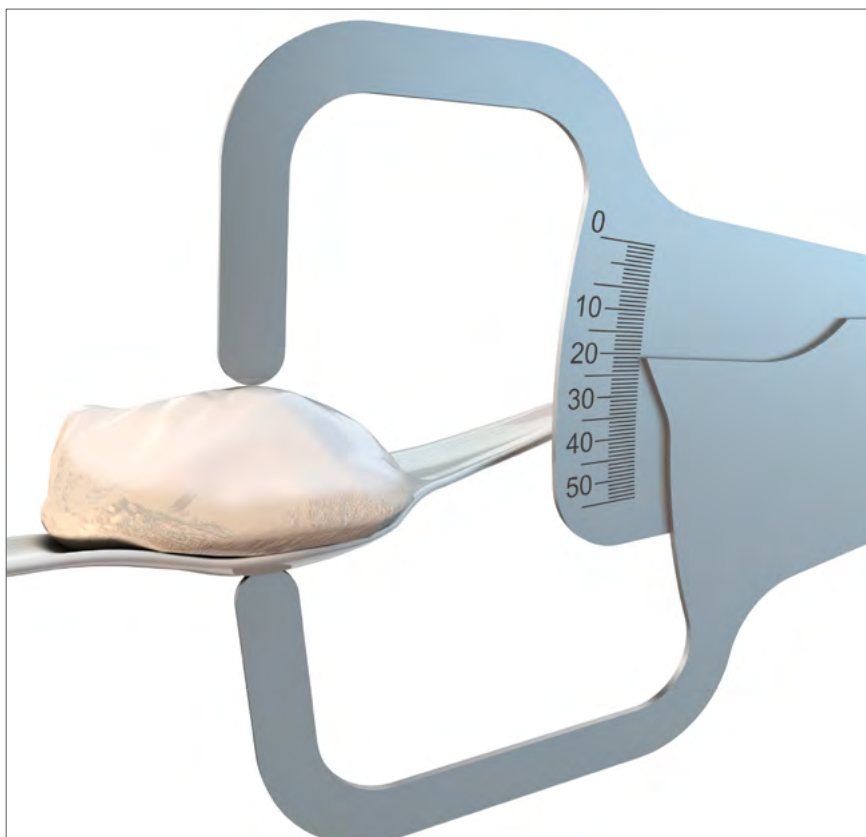



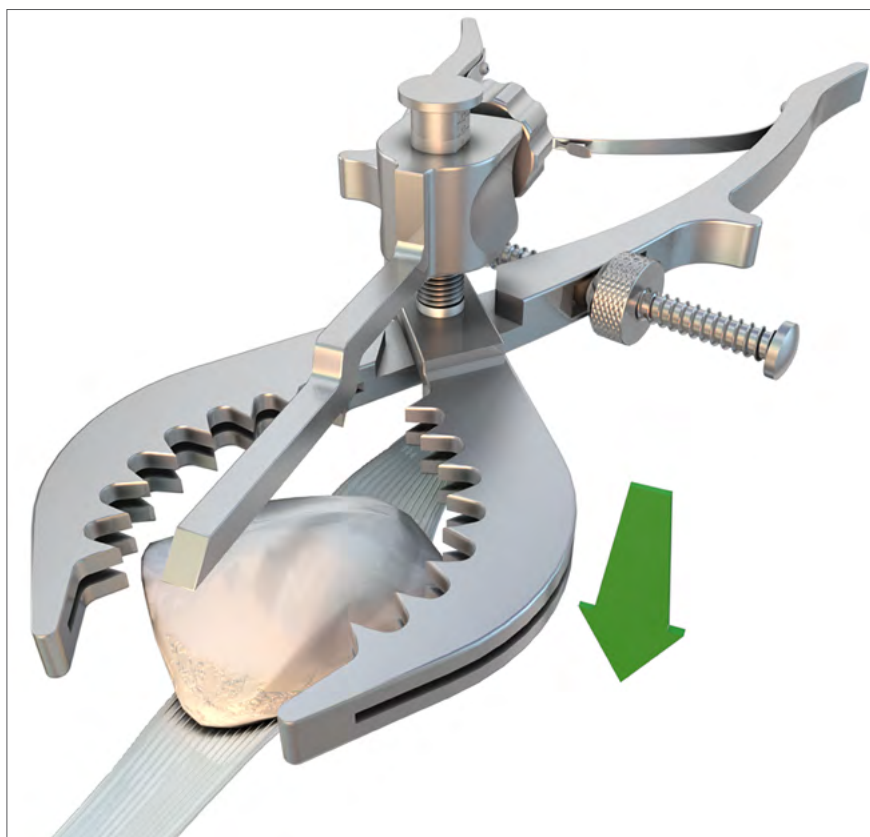

Set the gauge stylus on the clamping screw to a resection depth of 8 mm and lock it if a residual thickness of 10 mm is to be maintained. If the calculated residual thickness is less than 10 mm, the resection depth must be adjusted accordingly.

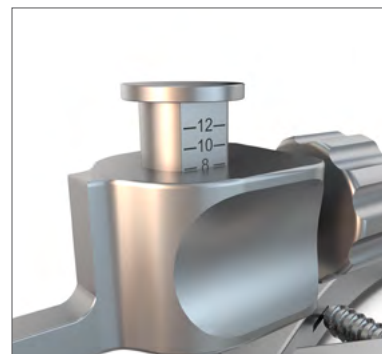

Apply the *Patella Gripper* to the posterior patella with the patient's leg in extension.

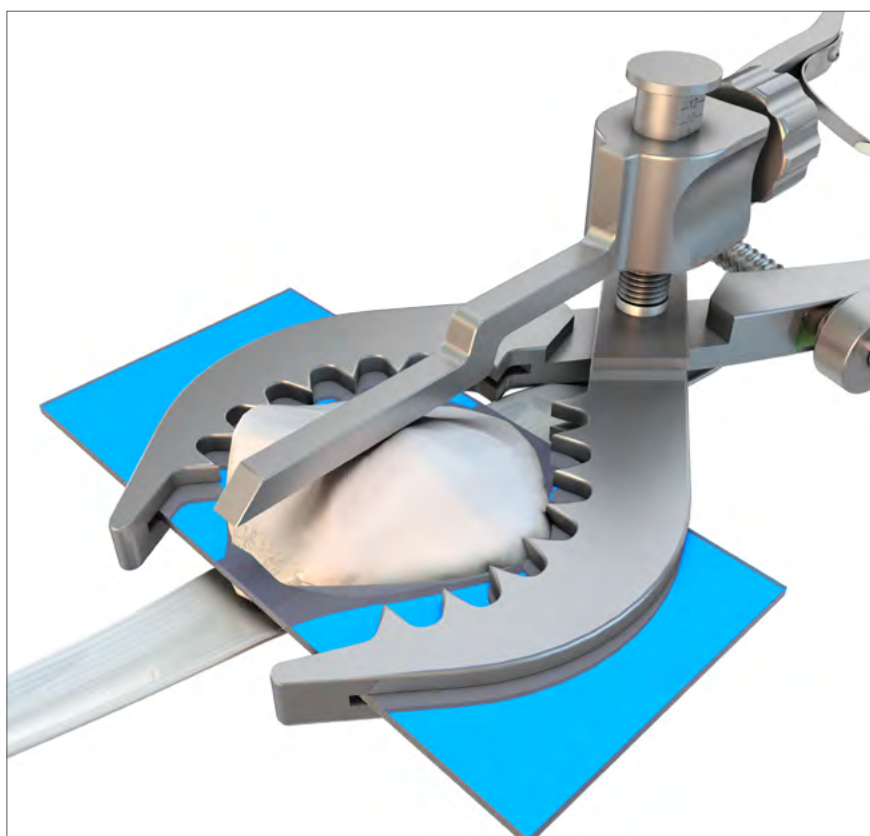

Then place the depth guide on the highest point of the patella, secure it with the locking screw, and perform the patellar osteotomy.

**! NOTE**

Please use only PETER BREHM saw blades. The thickness of the saw blades is  $1.18 \pm 0.01$  mm.

## 10 Patella Preparation

40

Determining the Size of the TRIAL PATELLA

### ! NOTE

The size of the patella corresponds to the size of the femoral component.

The *TRIAL PATELLA* is placed on the osteotomy surface to determine the diameter of the patella. The patellar component that best matches the osteotomy surface is selected for trial implantation.

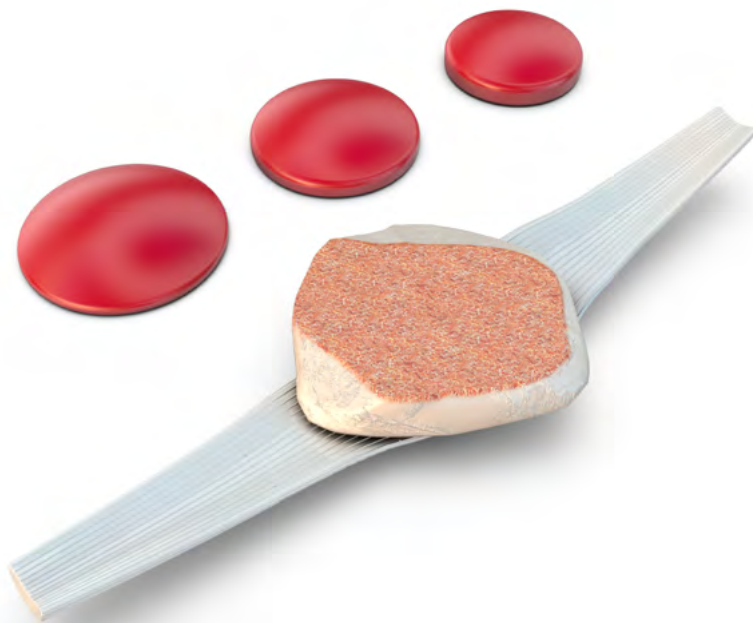

The *TRIAL Patella Base Plate* is placed on the *Patella Chimney*.



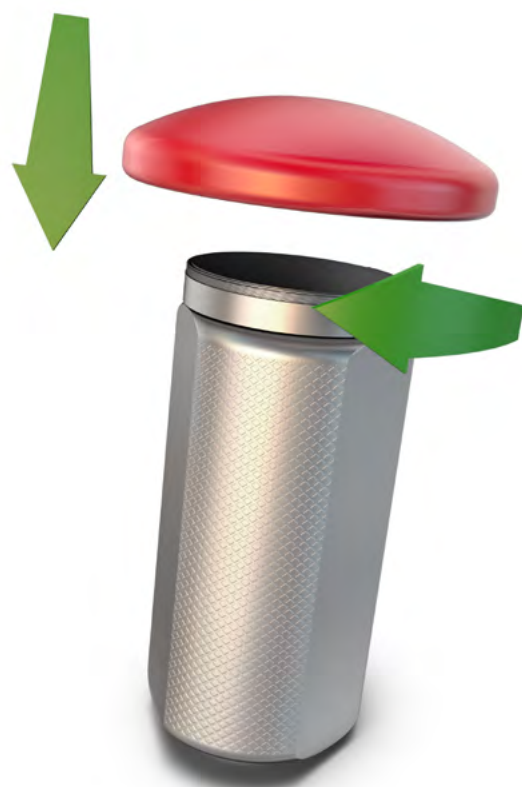

Then the desired *TRIAL PATELLA* is screwed onto the *TRIAL Patella Base Plate*.

## 10 Patella Preparation

41

### Aligning the TRIAL PATELLA and Drilling the Fixation Holes

The *TRIAL PATELLA* is then aligned on the osteotomy surface of the patella with the *TRIAL Patella Base Plate*. The spikes are pressed into the bone.

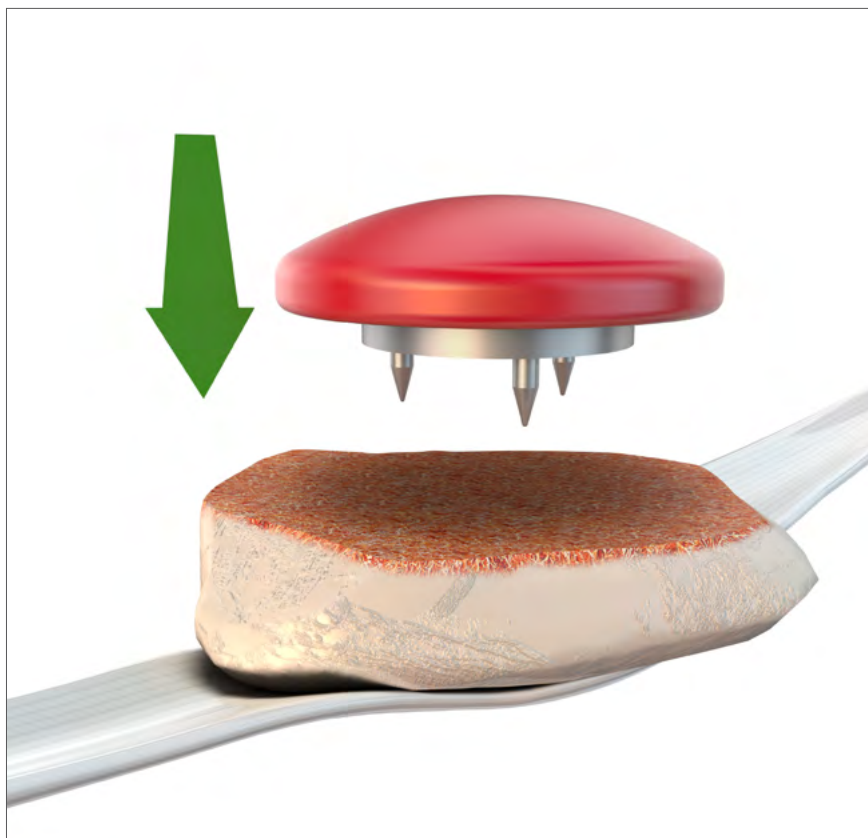

The spikes of the *Drilling Jig* are positioned in the same place as those of the *TRIAL Patella Base Plate*.

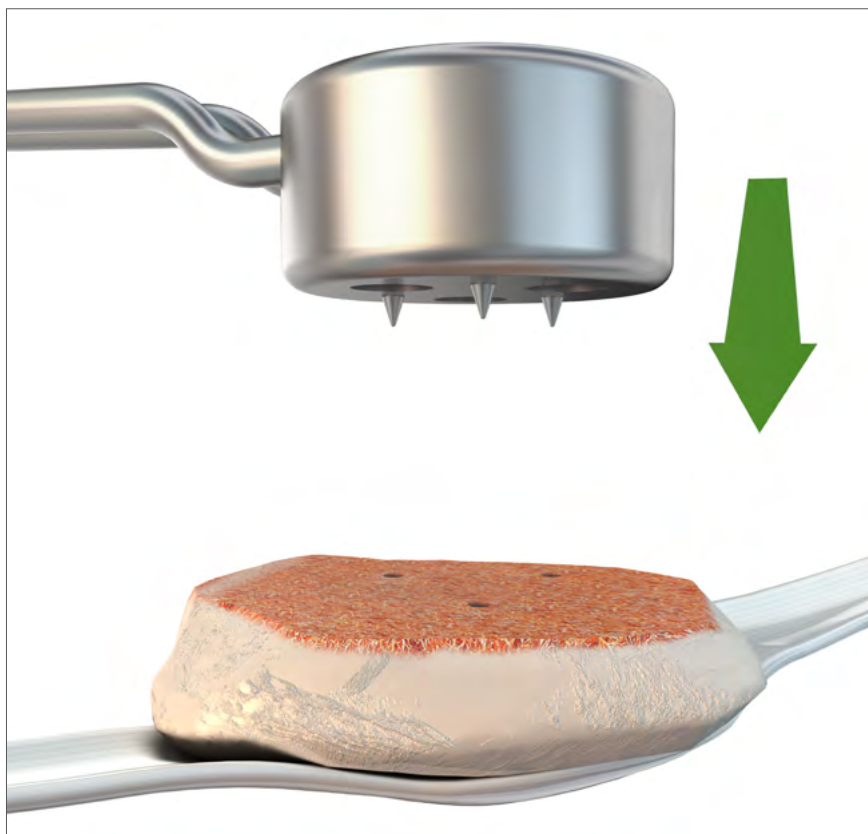

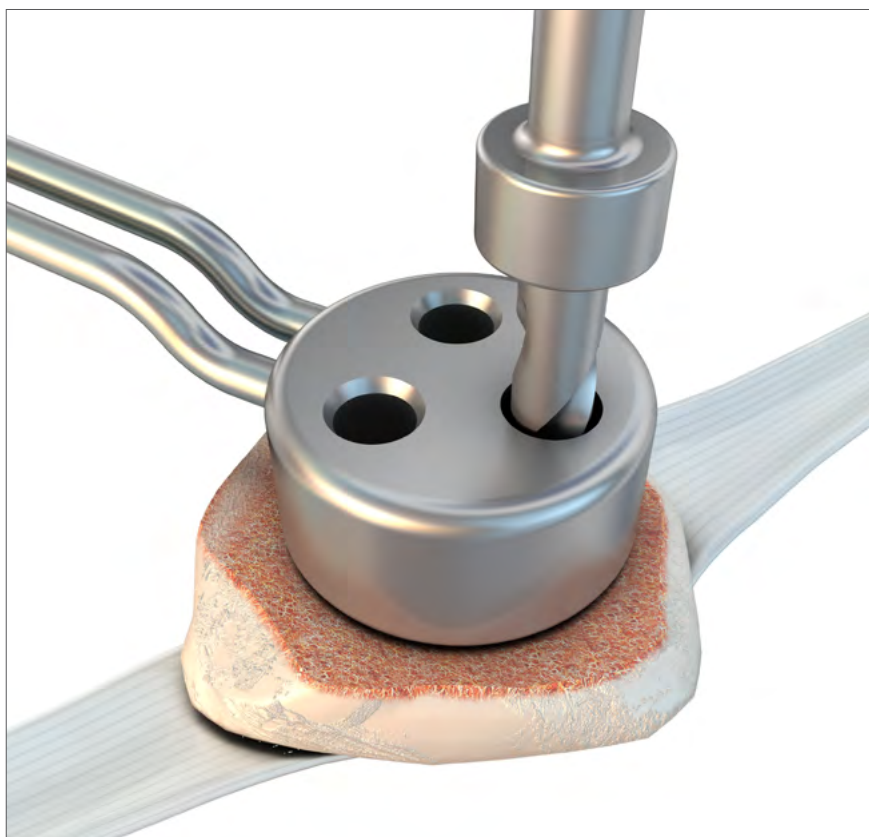

The holes for the lugs of the patellar component are prepared with the *Drill for femoral Lugs AO Coupling* Size:  $\varnothing$  6 mm.

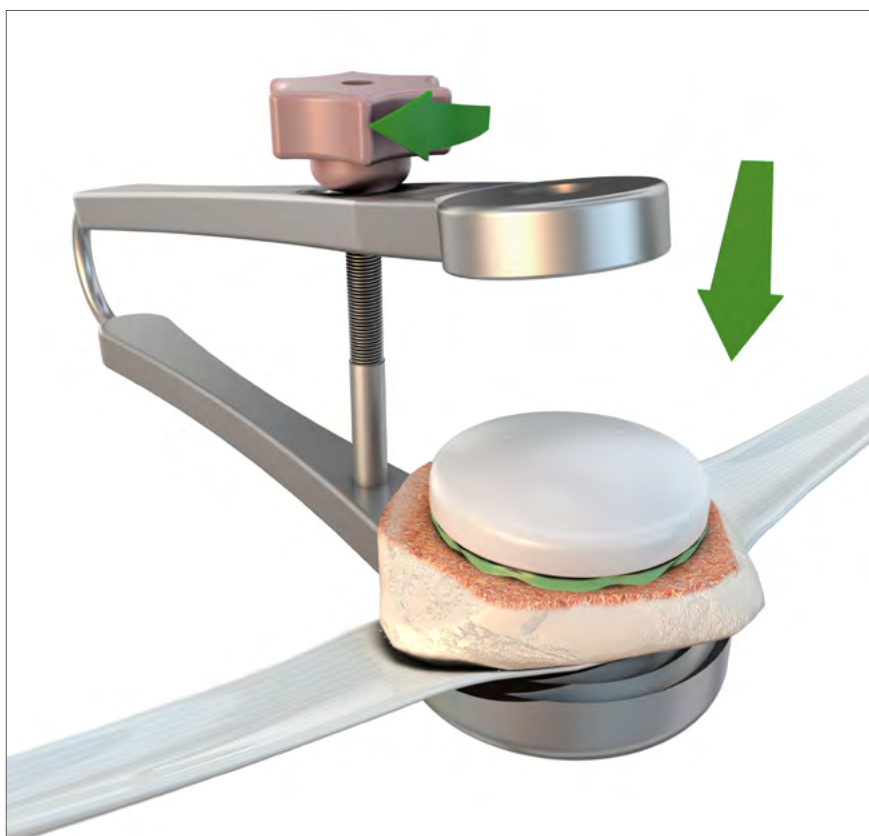

42

Implanting the Patella Component

**! NOTE**

The Patella Component of the BPK-S Integration system is only available cemented.

The Patella Component is pressed to the anterior surface of the patella with the *Cementing Pliers* and secured with the fixation screw.



## 10 Patella Preparation

Any excess cement is removed, and the *Cementing Plier* is removed after the cement has hardened.

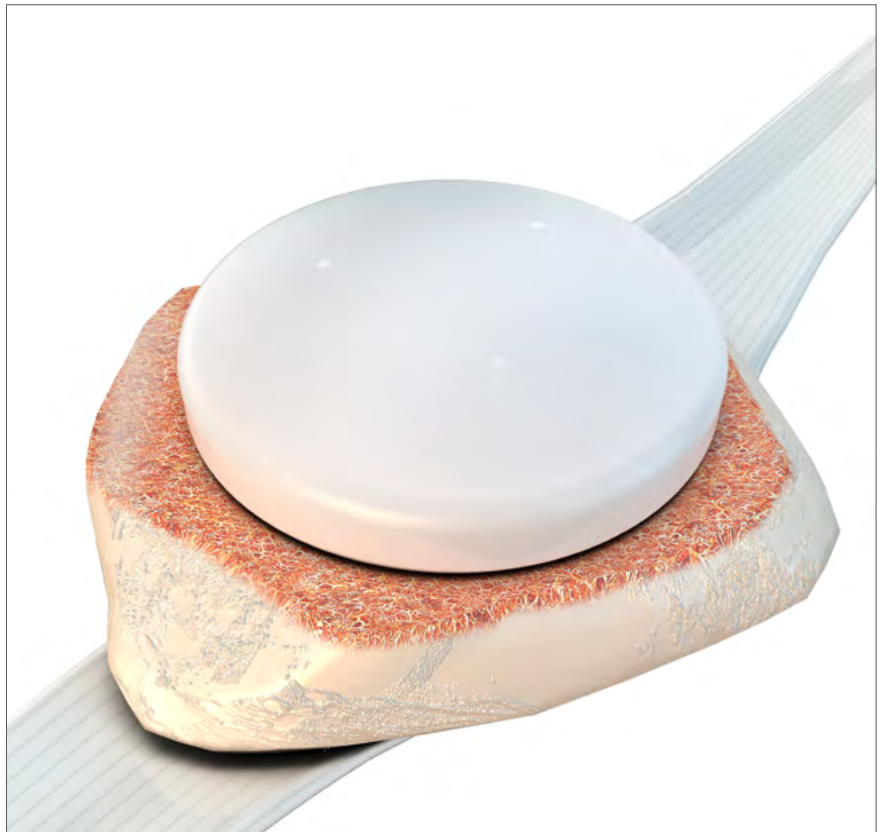
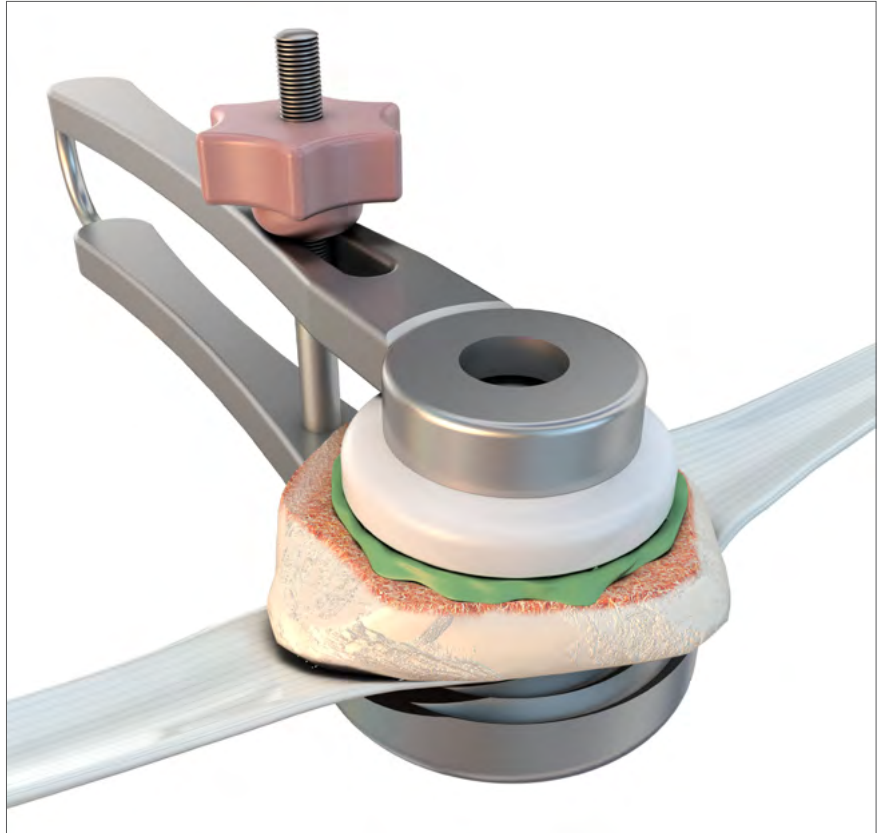



## 11 BPK-S Integration Appendix A – BPK-S Integration Ceramic



### Notes on BPK-S Integration Ceramic

The ceramic implants of the BPK-S Integration system may be used **only with cement**.

Use **only mobile polyethylene inserts** with the ceramic components. Fixed polyethylene inserts are not compatible with the BPK-S Integration Ceramic tibial component.

To avoid metal deposition on ceramic components resulting in third-body wear, ensure that no metal instruments or other metal objects get in contact with the ceramic implants. No metal instruments (forceps, scalpels) may be used to remove excess bone cement.

BPK-S Integration Ceramic is available in the following sizes: femoral component sizes 3, 4, 5, and 6; tibial component sizes 3, 4, 5, 6, 7, and 8 (no sealing screw required).

## 11 BPK-S Integration Appendix A – BPK-S Integration Ceramic

43

### Special Femoral Seating Instrument CERAMIC FEMUR Component UC

A special *Impactor / Extractor Ceramic Femoral Component* with “safecode” coating is used to implant the ceramic femoral component.

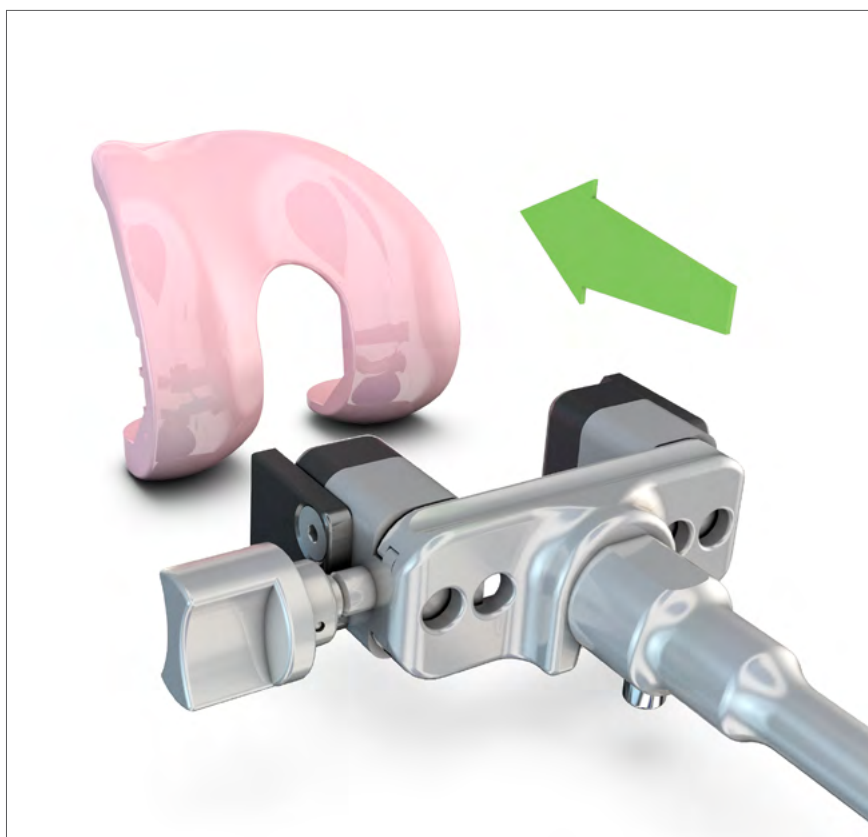

Make sure that the femoral component is not oblique in the seating instrument, that the jaws fully mesh with the femoral component, and that the screw is hand tight. Before and after every use, inspect the *Impactor / Extractor Ceramic Femoral Component* and verify that its “safecode” coating is intact. Residual cement must be immediately removed with a soft plastic instrument. Avoid using sharp instruments to clean it.

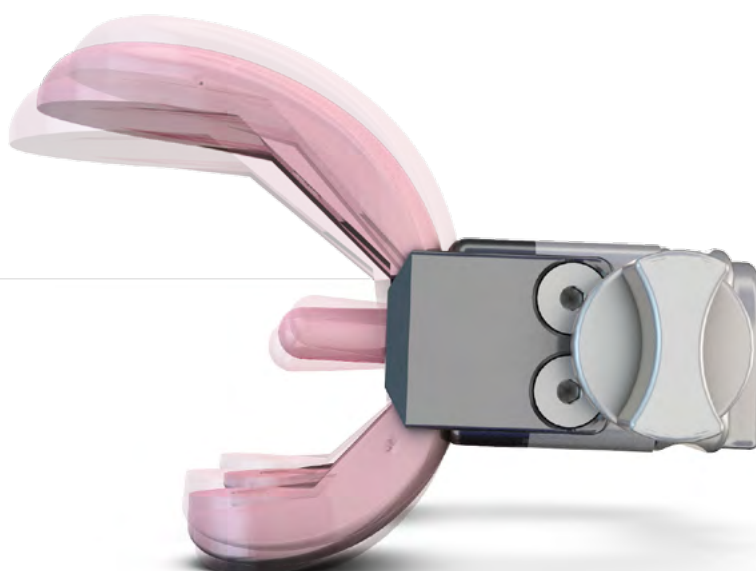

44

### Special Impactor CERAMIC TIBIA Component UC

Use a special *Impactor Ceramic Tibial Component* to implant the CERAMIC TIBIA Component UC.

The sealing ring must be inspected after each operation and before each use.



Seating the CERAMIC TIBIA Component UC with the *Impactor Ceramic Tibial Component*



Removing the CERAMIC TIBIA Component UC with the *Extractor Ceramic Tibial Component*

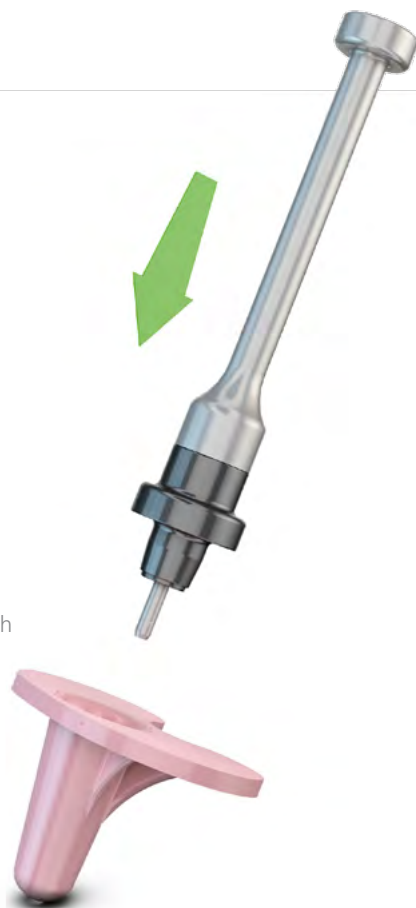

## 12 BPK-S Integration Appendix B – Size Combinations

Size Combinations for Femoral and Tibial Components (Primary)

		Tibia size							
		1	2	3	4	5	6	7	8
Femur size	1	■	■	■					
	2	■	■	■	■				
	3		■	■	■	■			
	4			■	■	■	■		
	5				■	■	■	■	
	6						■	■	■
	7						■	■	■

Size Combinations for Femoral and Patellar Components (Primary)

		Patella	Diameter			
			24	28	32	36
Femur size	1		■	■		
	2		■	■		
	3		■	■	■	
	4		■	■	■	■
	5			■	■	■
	6			■	■	■
	7			■	■	■

## 13 BPK-S Integration Appendix C – UC and UC/SC Components



### 1 FEMORAL Component UC Cemented / Cementless

- | Sizes 1, 2, 3, 4, 5, 6, 7 left and right

### FEMORAL Component UC Ceramic Cemented

- | Sizes 3, 4, 5, 6 left and right

### 2 Polyethylene INSERTS UC fix

- | Height 7-17 mm (2 mm increments)

### Polyethylene INSERTS UC Mobile

- | Height 7-17 mm (2 mm increments)

### Polyethylene INSERTS DD Mobile

- | Height 7-17 mm (2 mm increments)

### 3 TIBIAL Component UC/SC Cemented

- | Sizes 1, 2, 3, 4, 5, 6, 7, 8 left and right
- | Asymmetrical tibial component
- | 3° posterior slope
- | With stem coupling

### TIBIAL Component UC/SC Cementless

- | Sizes 1, 2, 3, 4, 5, 6, 7, 8 left and right
- | Asymmetrical tibial component
- | 3° posterior slope
- | With stem coupling

### TIBIAL Component UC Ceramic Cemented

- | Sizes 3, 4, 5, 6, 7, 8 left and right
- | Asymmetrical tibial component
- | 3° posterior slope

### 4 Patella

- | Sizes 1, 2, 3, 4, 5, 6, 7
- | Dia. 24/8 mm, 28/8 mm, 32/8 mm, 36/8 mm

14  
BPK-S Integration  
Appendix D –  
System Overview

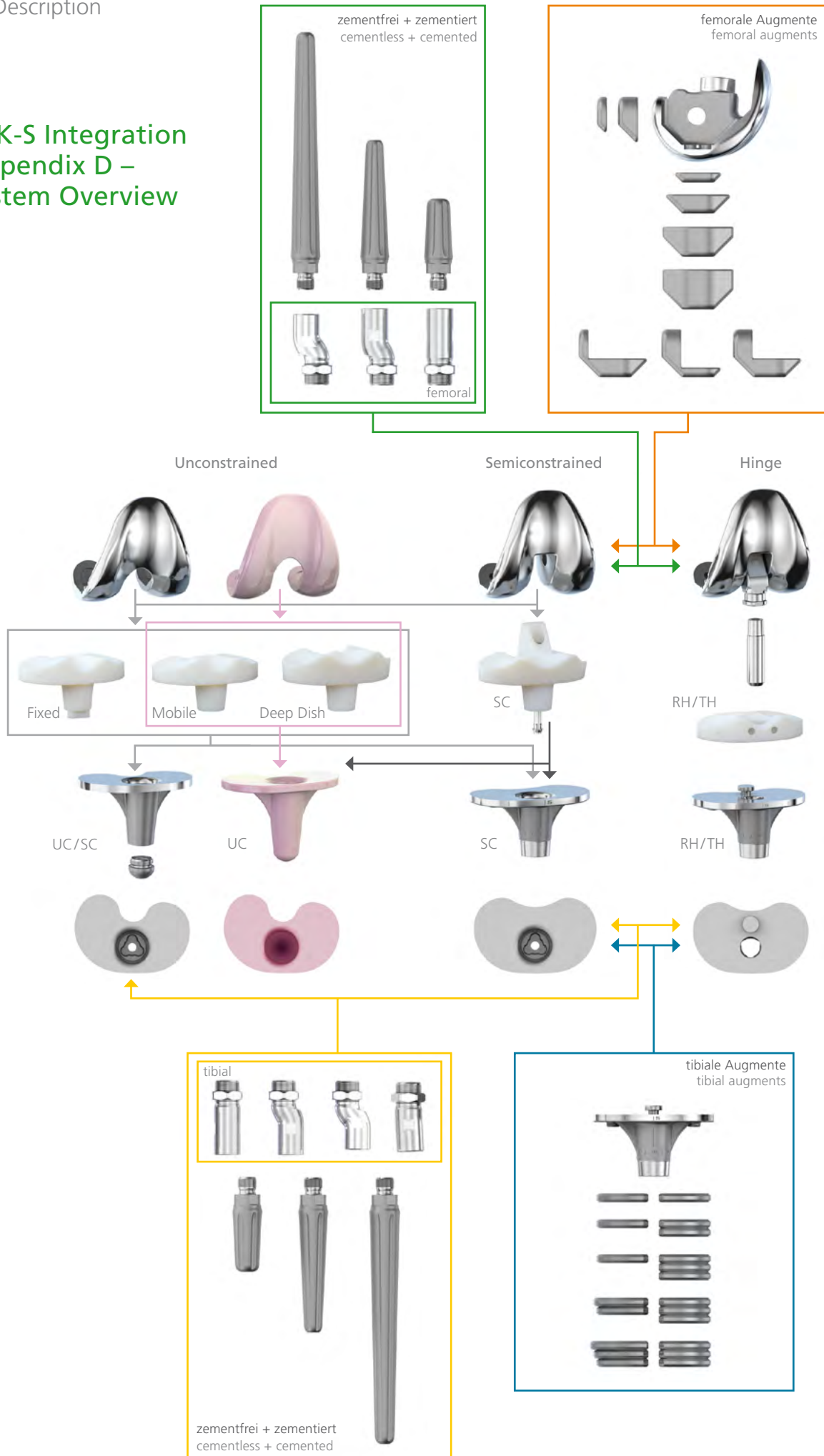



## 15 BPK-S Integration Appendix E – Dimensions – Femoral and Tibial Components

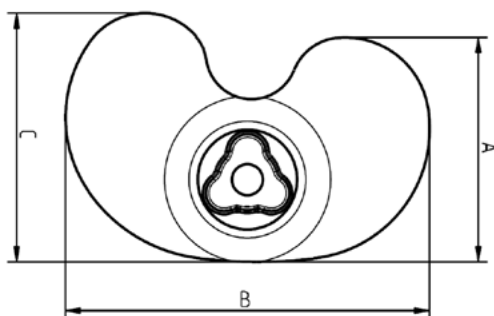

	A	B	C
Size	[mm]	[mm]	[mm]
1	36,9	60	40,9
2	38,8	63,2	43
3	41,1	66,5	45,3
4	43,3	70	47,7
5	45,9	74,2	50,5
6	48,6	78,7	53,5
7	51,6	83,4	56,8
8	54,7	88,4	60,2

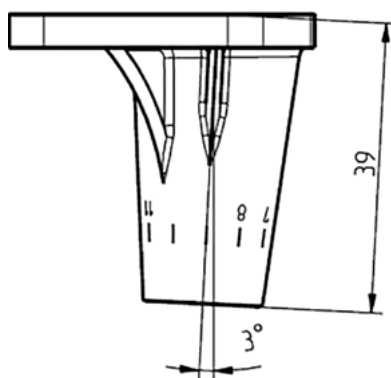

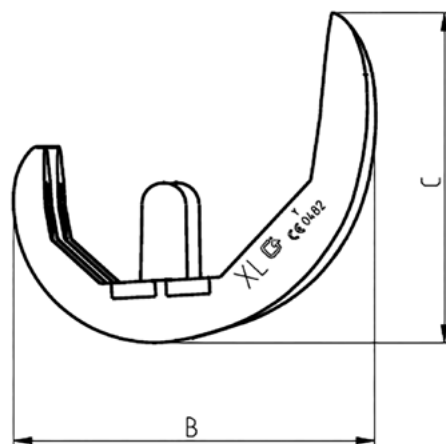
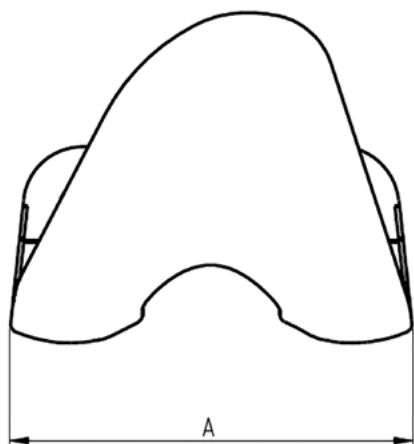

Size	A [mm]	B [mm]	C [mm]
1	55,6	50	45,6
2	58,5	52,6	48
3	61,5	55,4	50,4
4	65,5	59,4	53,6
5	70,8	64,2	57,9
6	77,2	70,2	63
7	83,8	76,5	69

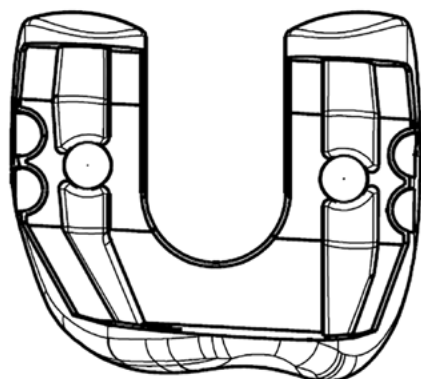





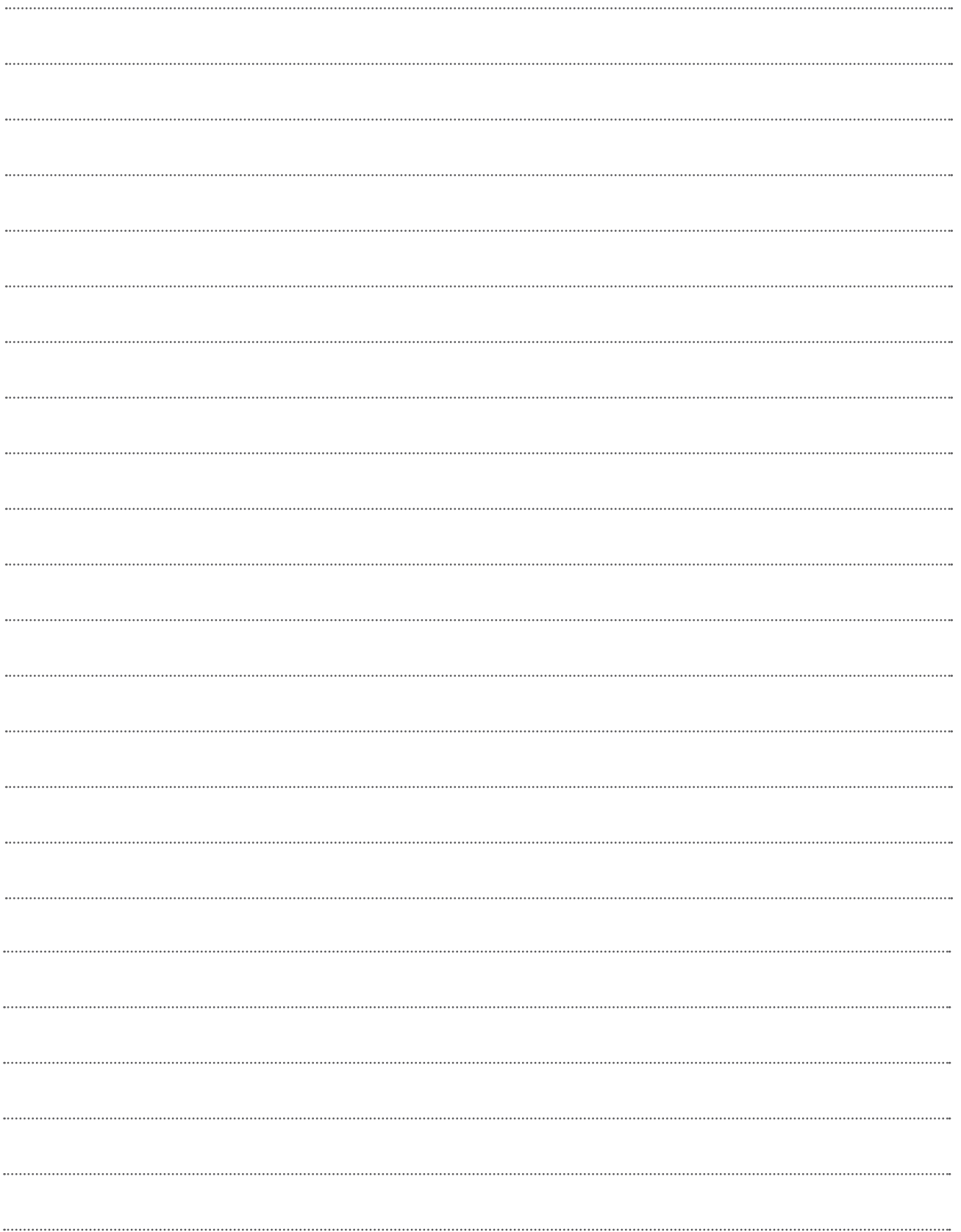

## ! NOTE

This brochure is intended for physicians only and is not suitable as a source of information for lay persons. The information about the products and/or procedures described in this brochure is of a general nature and does not represent the advice or recommendation of a physician. The information provided here does not in any way represent an opinion on the diagnosis or treatment of any specific medical case. The respective patient must be examined individually and advised accordingly. This brochure can neither completely nor partially substitute these measures.

The information contained in this brochure has been produced and compiled by medical experts and qualified PETER BREHM employees to the best of their knowledge. The greatest possible care has been taken to ensure that the information provided is correct and comprehensible.



**PETER BREHM**  
Die Präzision in Titan  
für den Menschen

PETER BREHM GmbH  
Am Mühlberg 30  
91085 Weisendorf

Telephone + 49 9135 - 71 03 - 0  
Facsimile + 49 9135 - 71 03 - 16

[www.peter-brehm.de](http://www.peter-brehm.de)

